

WKP-P

Rectangular
fire damper

Technical Documentation



 2434	
SMAY Sp. z o.o. 22 CSWU:2434-CPR-0285 DWU:024-CPR-2017	
PN-EN 12101:2012 Fire damper type: WKP-P	
Nominal activation conditions/sensitivity: Closing/opening during the test at the right time	Automatic starting Pass
Response time/Closure time:	Automatic starting Pass
Reliability:	300 cycles <120s. – single 10 000 cycles <120s. – multi
Fire resistance:	
Fire integrity - E Fire insulation - I Smoke leakage - S Mechanical stability (under E) Maintenance of the cross section (under E)	E ₆₀₀ 120 (V _{ed} i↔o) S1000 C ₃₀₀ AA single EI 120 (V _{ew} i↔o) S1000 C ₁₀₀₀₀ AA multi EI 90 (V _{ew} i↔o) S1500 C ₁₀₀₀₀ AA multi
Durability:	
Response delay Operating reliability	Pass 300 cycles <120s. – single 10 000 cycles <120s. – multi

Version 6.2

SMAY reserves the right to make changes to this document.

TABLE OF CONTENT

1.	INTRODUCTION.....	3
2.	LEGAL REGULATIONS.....	3
3.	INTENDED USE	3
4.	TECHNICAL DESCRIPTION	5
5.	BELIMO ELECTRIC ACTUATORS USED IN WKP-P.....	6
6.	ACCESSORIES FOR WKP DAMPERS	12
7.	CONDITIONS OF TRANSPORT AND STORAGE	13
8.	INSTALLATION TECHNOLOGY.....	13
8.1.	INSTALATION TECHNOLOGY – RIGID WALL	14
8.1.1.	PROMADUCT	17
8.2.	INSTALLATION TECHNOLOGY – STRUCTURES THICKER THAN 125 MM.....	18
8.3.	INSTALLATION TECHNOLOGY – FLEXIBLE WALL WITH 125MM THICKNESS	19
8.4.	INSTALLATION TECHNOLOGY – MKW HONEYCOMB MESH COVER AND KST GRILLE .	20
9.	COMMISSIONING	22
10.	PERIODIC MAINTENANCE AND SERVICING RULES	25
11.	CLASSIFICATION OF DAMPERS FOR REPAIR	30
12.	WARRANTY CONDITIONS.....	30

1. INTRODUCTION

The purpose of technical documentation is to familiarize the user with the intended use, design, operation principle, installation, periodic maintenance and operation of product.

2. LEGAL REGULATIONS

The WKP-P-E dampers are certified by **CTO Gdańsk**, Certificate of Constancy of Performance **2434-CPR-0015**.

The dampers are symmetrical, designed for installation in vertical building partitions (in walls). They may be mounted in rigid or flexible walls.

The dampers are designed, manufactured and tested in accordance with the following standards: **PN-EN 12101-8** "Smoke and heat control systems – Part 8: Smoke control dampers" and **PN-EN 13501-4** "Fire classification of construction products and building elements – Part 4: Classification using data from fire resistance tests on components of smoke control systems."

The effectiveness of the dampers is confirmed by tests according to **PN-EN 1366-2 and PN-EN 1366-10** "Fire resistance tests for service installations – Part 2: Fire dampers, Part 10: Smoke control dampers."

The WKP-P-E-W fire dampers are classified as **tightness class C** (housing tightness) devices on the basis of tests carried out according to **EN 1751** "Ventilation for buildings. Air terminal devices. Aerodynamic testing of dampers and valves."

3. INTENDED USE

WKP-P fire dampers are classified in the following fire resistance range and can be mounted in the following building partitions:

- a. **E₆₀₀ 120 (v_{ed} i↔o) S1000 C₃₀₀ AAsingle** – directly on horizontal fire ventilation ducts,
- b. **EI 120 (v_{ew} i↔o) S1000 C₁₀₀₀₀ AAmulti** – vertical or horizontal axis of rotation of the baffles. In rigid standard structures with 120 mm thickness or more, In standard structures with 125 mm thickness or more, with fire resistance class EI120 or higher
- c. **EI 90 (v_{ew} i↔o) S1500 C₁₀₀₀₀ AAmulti** – vertical or horizontal axis of rotation of the baffles. In rigid standard structures with 120 mm thickness or more, In standard structures with 125 mm thickness or more, with fire resistance class EI90 or higher

where:

E – fire integrity,

I – fire insulation,

S – smoke leakage,

120/90 – duration of fulfilment of E, I and S criteria, expressed in minutes,

v_{ed} – damper mounted directly in the duct,

v_{ew} – damper mounted directly in the wall,

i↔o – operating effectiveness criteria are fulfilled from the inside to the outside (fire inside), and from the outside to the inside (fire outside),

1500, 1000 – acceptable underpressure in the installation, expressed in pascals

C₁₀₀₀₀ – the suitability of the damper for use in combined smoke control and general ventilation systems,

AA – automatic starting,

single – acceptable installation in installations serving one fire zone,

multi – acceptable installation in installations serving more than one fire zone.

The WKP-P-E-W fire dampers may be installed in vertical building partitions with both horizontal and vertical baffle rotation axis, the damper may be rotated in the way enabling on location of actuator on left or right side and on top or bottom.

WKP-P fire dampers are intended for installation on internal and external building partitions as also at a distance from them. In case of external wall installation, use of finishing element is required (intake or exhaust), which will protect from influence of atmospheric factors. Drive system (actuator) should be installed inside facility. It is recommended to use dampers in special execution (impregnated fireproof boards, anti-corrosive steel elements).

WKP-P fire dampers may also be installed in building partitions having a smaller fire resistance. In this case, the damper's fire resistance is equal to the building partitions fire resistance, considering the smoke leakage criterion.

Table 1. Table of fire resistance

WKP-P			
Construction type	Minimum thickness of the building partitions mm	Fire resistance class	Sealing type
Rigid wall	≥120 mm	EI 120 (v _{ew} i↔o) S1000 C _{10 000} AA _{multi}	MORTAR
	≥125 mm	EI 120 (v _{ew} i↔o) S1000 C _{10 000} AA _{multi}	MINERAL WOOL
	≥120 mm	EI 90 (v _{ew} i↔o) S1500 C _{10 000} AA _{multi}	MORTAR
	≥125 mm	EI 90 (v _{ew} i↔o) S1500 C _{10 000} AA _{multi}	MINERAL WOOL
Flexible wall	≥125 mm	EI 120 (v _{ew} i↔o) S1000 C _{10 000} AA _{multi}	MINERAL WOOL
	≥125 mm	EI 90 (v _{ew} i↔o) S1500 C _{10 000} AA _{multi}	MINERAL WOOL
Steel duct	-	E ₆₀₀ 120 (v _{ed} i↔o) S1000 C ₃₀₀ AA _{single}	-

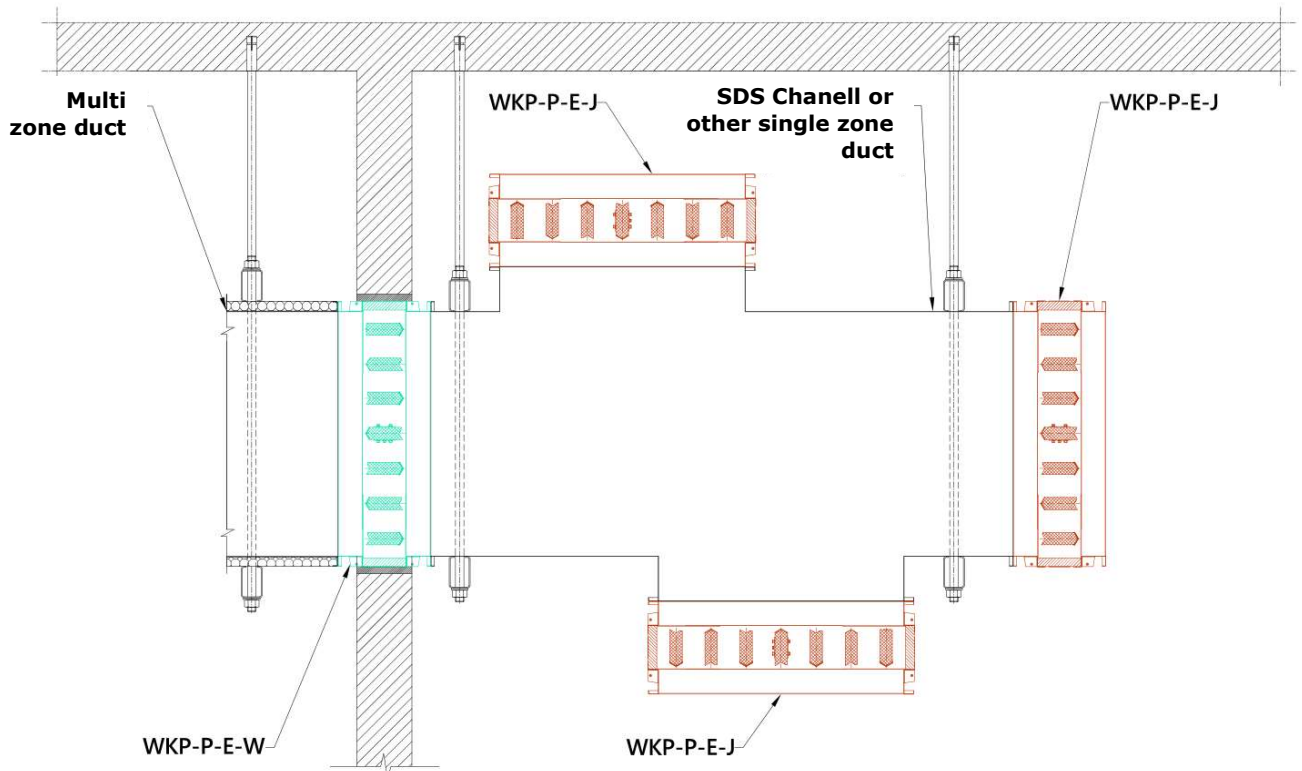

Figure 1. Scheme of the use of WKP dampers in single and multi-zone variants.

4. TECHNICAL DESCRIPTION

The WKP-P dampers are made up of a rectangular housing, movable blades and a drive system.

The dampers' housing is made of fire-rated boards and steel structural members. Both sides of the housing are equipped with steel connection spigots, which enable easy connection of a duct.

In a transfer version connection frames are not mounted.

Movable blades, made of mineral silicate composite, are fastened to the housing by means of metal pins.

There are intumescent seals mounted on the inner side of the housing and on the blades. Their characteristic feature is the volume increase at high temperatures, tightly filling all leaks between the baffle and the body. A bubble seal ensures the leak tightness at ambient temperature.

The WKP damper is provided with an innovative actuating mechanism, which ensures the counter rotation of the blades.

The mechanism is made up of, among other things, gears made of fire-rated materials, blades and an electric actuator.

The permissible air velocity for the WKP-P-E damper in a B x H connection duct is 12 m/s.

During normal operation of the system, blades can be in open or in closed position.

The BEN, BEE or BE electric actuator by BELIMO is used as the drive system. Switching between open and closed position of the damper (and vice versa) can be done after the power supply has been connected to the actuator. There are microswitches permanently installed in the actuator for indicating the open/ closed position of the damper. The WKP-J and WKP-W dampers do not have return springs (voltage loss will not cause the movement of the damper isolating baffle).

The range of dampers covers the following dimensions: a clear damper width from 200 to 1200 mm (10 mm intervals) and clear damper height from 200 to 800 mm (100 mm intervals).

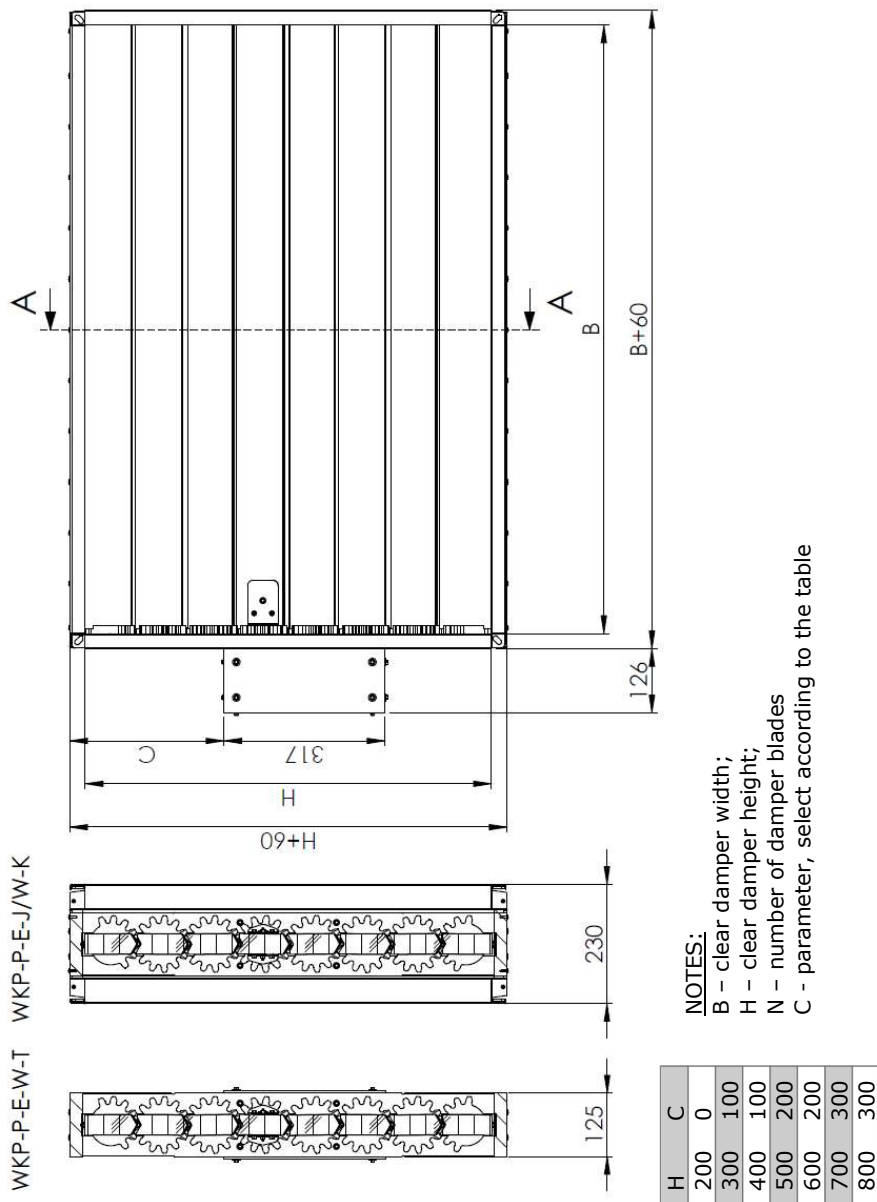

Figure 2. WKP-P damper

Table 2. WKP-P weight [kg]

		Width, B [mm]										
		200	300	400	500	600	700	800	900	1000	1100	1200
Height, H [mm]	200	12	14	16	17	19	20	22	25	27	29	30
	300	14	15	17	19	21	23	25	27	29	31	32
	400	15	18	19	21	23	26	27	29	31	33	35
	500	16	18	20	22	25	28	30	32	34	36	39
	600	17	19	22	25	27	30	32	35	37	39	42
	700	18	21	24	27	29	32	34	37	40	42	45
	800	19	23	26	28	31	34	37	40	42	45	48

5. BELIMO ELECTRIC ACTUATORS USED IN WKP-P

Actuator BEN series:

- BEN230,
- BEN24,
- BEN24-ST,
- BEN24-SR.

where:

ST - connection plug
 SR - analog control



Actuator BEE series:

- BEE230,
- BEE24,
- BEE24-ST,
- BEE24-SR.

where:

ST - connection plug
 SR - analog control



Actuator BE series:

- BE230,
- BE24,
- BE24-ST.

where:

ST - connection plug



Wiring diagram BLE230 and BE230

AC 230 V, open-close

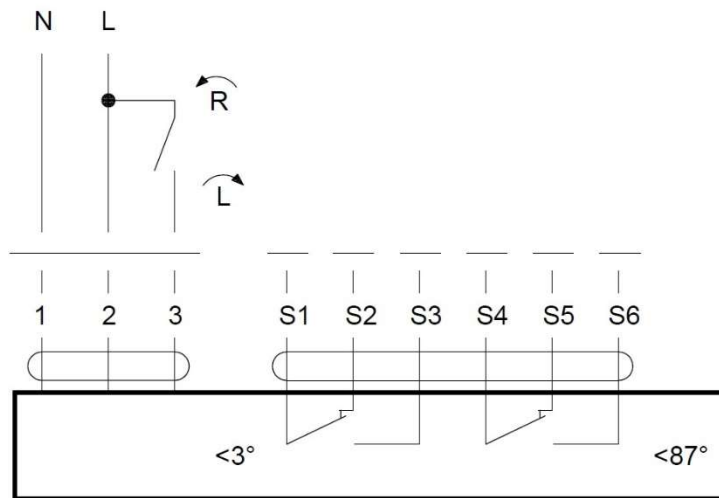

AC 230 V, open-close

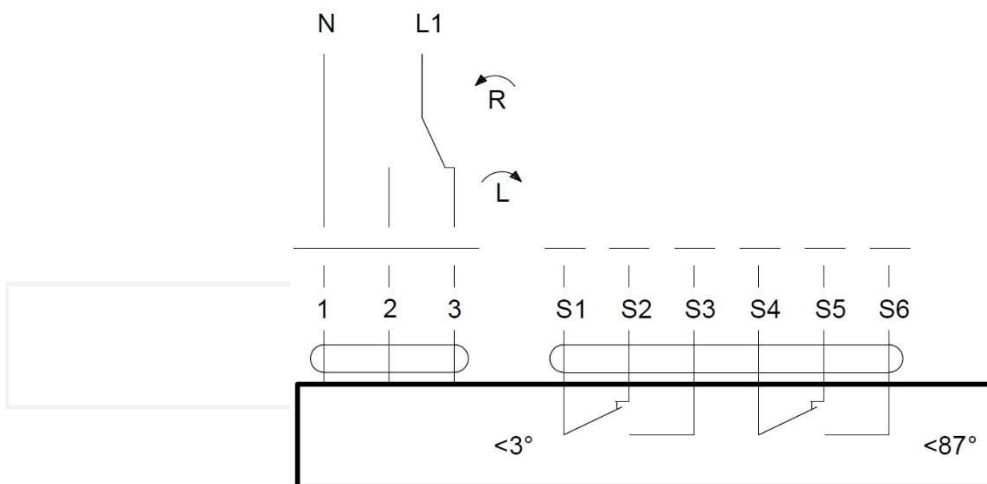

Wiring diagram BLE24 and BE24

AC/DC 24V, open-close

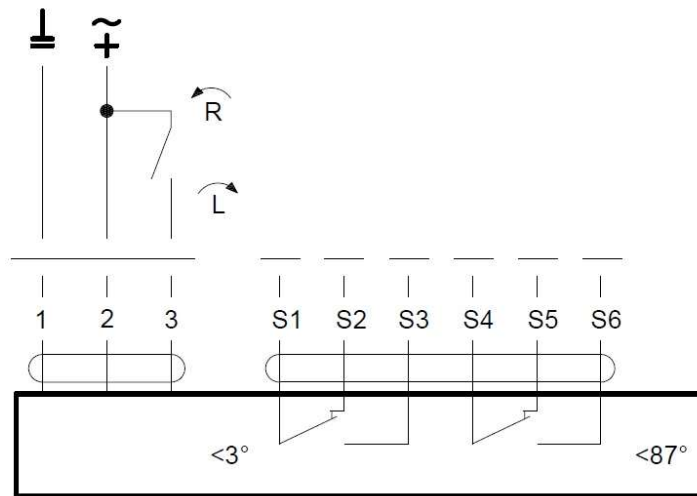

AC/DC 24V, open-close

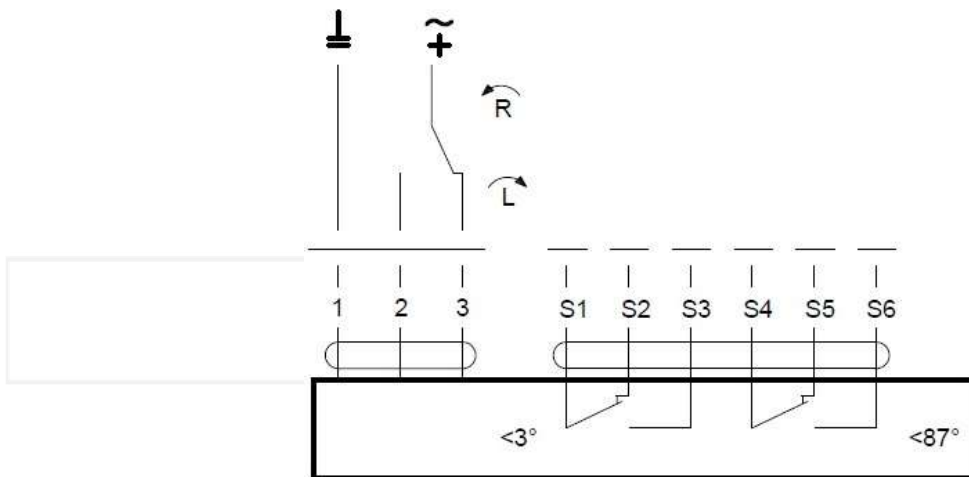

Wiring diagram BLE24-ST and BE24-ST

Application with SBSE-Control

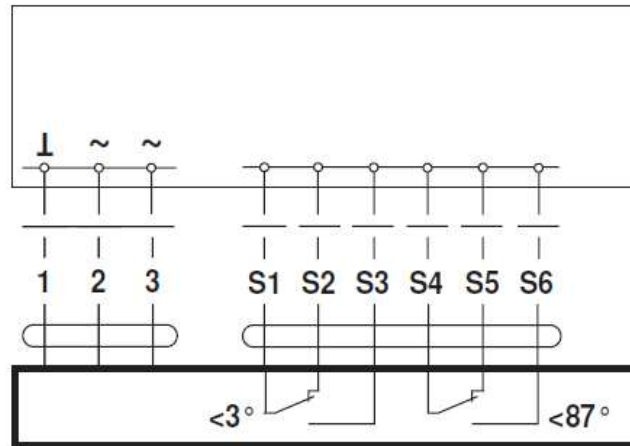
Technical data:
BEN230
BEN24 (-ST)

Nominal voltage	AC 230 V	AC/DC 24 V
Nominal voltage frequency	50/60 Hz	50/60 Hz
Nominal voltage range	AC 198...264 V	AC 19.2...28.8 V / DC 21.6...28.8 V
Switching thresholds min. ON voltage	AC 198V	AC 19.2 V / DC 21.6 V
Switching thresholds max. OFF voltage	AC 50 V	AC 5 V / DC 7 V
Power consumption in operation	4 W	3 W
Power consumption in rest position	0.4 W	0.1 W
Power consumption for wire sizing	7 VA	6 VA
Power consumption for wire sizing note	$I_{max} 4 A @ 5 ms$	$I_{max} 8.2 A @ 5 ms$
Auxiliary switch	2 x SPDT	2 x SPDT
Switching capacity auxiliary switch	1 mA...3 (0.5 inductive) A, AC 250 V	1 mA...3 (0.5 inductive) A, AC 250 V
Switching points auxiliary switch	$5^\circ / 80^\circ$	$5^\circ / 80^\circ$
Tolerance	$\pm 3^\circ$	$\pm 3^\circ$
Connection supply / control	Cable 1 m, 3 x 0.75 mm ² , halogen-free	Cable 1 m, 3 x 0.75 mm ² , halogen-free
Connection auxiliary switch	Cable 1 m, 6 x 0.75 mm ² , halogen-free	Cable 1 m, 6 x 0.75 mm ² , halogen-free
Nominal torque	15 Nm	15 Nm
Direction of rotation motor	can be selected by mounting	can be selected by mounting
Manual override	with hand crank	with hand crank
Angle of rotation	Max. 95°	Max. 95°
Running time motor	<30s / 90°	<30s / 90°
Sound power level, motor	58 dB(A)	58 dB(A)
Spindle driver	Form fit 12x12 mm, Continuous hollow shaft	Form fit 12x12 mm, Continuous hollow shaft
Position indication	Mechanically, with pointer	Mechanically, with pointer
Service life	Min. 10,000 cycles	Min. 10,000 cycles
Protection class IEC/EN	II reinforced insulation	III Safety Extra-Low Voltage (SELV)
Protection class auxiliary switch IEC/EN	II reinforced insulation	II reinforced insulation
Degree of protection IEC/EN	IP54	IP54
EMC	CE according to 2014/30/EU	CE according to 2014/30/EU
Low voltage directive	CE according to 2014/35/EU	CE according to 2014/35/EU
Certification IEC/EN	IEC/EN 60730-1 and IEC/EN 60730-2-14	IEC/EN 60730-1 and IEC/EN 60730-2-14
Mode of operation	Type 1.B	Type 1.B
Rated impulse voltage supply / control	4 kV	0.8 kV
Rated impulse voltage auxiliary switch	4 kV	4 kV
Control pollution degree	3	3
Ambient temperature	-30...55 °C	-30...55 °C
Non-operating temperature	-40...80 °C	-40...80 °C
Ambient humidity	Max. 95% r.h., non-condensing	Max. 95% r.h., non-condensing
Maintenance	Maintenance-free	Maintenance-free
Weight	0.9 kg	0.9 kg

Technical data:

	BEE230	BEE24 (-ST)
Nominal voltage	AC 230 V	AC/DC 24 V
Nominal voltage frequency	50/60 Hz	50/60 Hz
Nominal voltage range	AC 198...264 V	AC 19.2...28.8 V / DC 21.6...28.8 V
Switching thresholds min. ON voltage	AC 198V	AC 19.2 V / DC 21.6 V
Switching thresholds max. OFF voltage	AC 50 V	AC 5 V / DC 7 V
Power consumption in operation	3.5 W	2.5 W
Power consumption in rest position	0.4 W	0.1 W
Power consumption for wire sizing	6 VA	5 VA
Power consumption for wire sizing note	I _{max} 4 A @ 5 ms	I _{max} 8.2 A @ 5 ms
Auxiliary switch	2 x SPDT	2 x SPDT
Switching capacity auxiliary switch	1 mA...3 (0.5 inductive) A, AC 250 V	1 mA...3 (0.5 inductive) A, AC 250 V
Switching points auxiliary switch	5° / 80°	5° / 80°
Tolerance	±3°	±3°
Connection supply / control	Cable 1 m, 3 x 0.75 mm ² , halogen-free	Cable 1 m, 3 x 0.75 mm ² , halogen-free
Connection auxiliary switch	Cable 1 m, 6 x 0.75 mm ² , halogen-free	Cable 1 m, 6 x 0.75 mm ² , halogen-free
Nominal torque	25 Nm	25 Nm
Direction of rotation motor	can be selected by mounting	can be selected by mounting
Manual override	with hand crank	with hand crank
Angle of rotation	Max. 95°	Max. 95°
Running time motor	<60s / 90°	<60s / 90°
Sound power level, motor	58 dB(A)	58 dB(A)
Spindle driver	Form fit 12x12 mm, Continuous hollow shaft	Form fit 12x12 mm, Continuous hollow shaft
Position indication	Mechanically, with pointer	Mechanically, with pointer
Service life	Min. 10,000 cycles	Min. 10,000 cycles
Protection class IEC/EN	II reinforced insulation	III Safety Extra-Low Voltage (SELV)
Protection class auxiliary switch IEC/EN	II reinforced insulation	II reinforced insulation
Degree of protection IEC/EN	IP54	IP54
EMC	CE according to 2014/30/EU	CE according to 2014/30/EU
Low voltage directive	CE according to 2014/35/EU	CE according to 2014/35/EU
Certification IEC/EN	IEC/EN 60730-1 and IEC/EN 60730-2-14	IEC/EN 60730-1 and IEC/EN 60730-2-14
Mode of operation	Type 1.B	Type 1.B
Rated impulse voltage supply / control	4 kV	0.8 kV
Rated impulse voltage auxiliary switch	4 kV	4 kV
Control pollution degree	3	3
Ambient temperature	-30...55 °C	-30...55 °C
Non-operating temperature	-40...80 °C	-40...80 °C
Ambient humidity	Max. 95% r.h., non-condensing	Max. 95% r.h., non-condensing
Maintenance	Maintenance-free	Maintenance-free
Weight	1.1 kg	1.1 kg

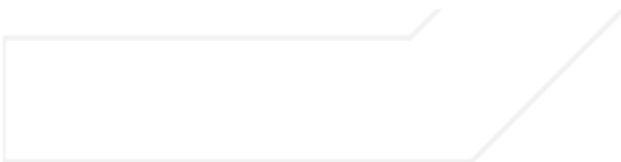

Technical data:	BE230	BE24 (-ST)
Nominal voltage	AC 230 V	AC/DC 24 V
Nominal voltage frequency	50/60 Hz	50/60 Hz
Nominal voltage range	AC 198...264 V	AC 19.2...28.8 V / DC 21.6...28.8 V
Switching thresholds min. ON voltage	AC 198 V	AC 19.2 V / DC 21.6 V
Switching thresholds max. OFF voltage	AC 100 V	AC 6.5 V / DC 6.5 V
Power consumption in operation	8 W	12 W
Power consumption in rest position	0.5 W	0.5 W
Power consumption for wire sizing	15 VA	18 VA
Power consumption for wire sizing note	I _{max} 7.9 A @ 5 ms	I _{max} 8.2 A @ 5 ms
Auxiliary switch	2 x SPDT	2 x SPDT
Switching capacity auxiliary switch	1 mA...6 (3) A, DC 5 V...AC 250 V (II Protective insulated)	1 mA...6 (3) A, DC 5 V...AC 250 V (II Protective insulated)
Switching points auxiliary switch	3° / 87° (in relation to 0...90°)	3° / 87° (in relation to 0...90°)
Tolerance	±2°	±2°
Connection supply	Cable 1 m, 3 x 0.75 mm ² , halogen-free	Cable 1 m, 3 x 0.75 mm ² , halogen-free
Connection auxiliary switch	Cable 1 m, 6 x 0.75 mm ² , halogen-free	Cable 1 m, 6 x 0.75 mm ² , halogen-free
Torque motor	Min. 40 Nm	Min. 40 Nm
Inhibiting torque dynamic	40 Nm	40 Nm
Inhibiting torque static (voltage-free)	50 Nm	50 Nm
Direction of rotation motor	Can be selected by mounting L/R	Can be selected by mounting L/R
Angle of rotation	100° (including 5° mechanical overrun at both sides)	Max. 100° (including 5° mechanical overrun at both sides)
Running time motor	<60 s / 90°	<60 s / 90°
Sound power level motor	62 dB(A)	62 dB(A)
Spindle driver	Form fit 14 mm	Form fit 14 mm
Position indication	Mechanically, with pointer	Mechanically, with pointer
Service life	Min. 10,000 cycles	Min. 10,000 cycles
Protection class IEC/EN	II Protective insulated	III Safety extra-low voltage
Degree of protection IEC/EN	IP54	IP54
EMC	CE according to 2004/108/EC	CE according to 2004/108/EC
Low voltage directive	CE according to 2006/95/EC	CE according to 2006/95/EC
Certification IEC/EN	IEC/EN 60730-1 and IEC/EN 60730-2-14	IEC/EN 60730-1 and IEC/EN 60730-2-14
Mode of operation	Type 1.B	Type 1.B
Rated impulse voltage supply	4 kV	0.8 kV
Rated impulse voltage auxiliary switch	2.5 kV	2.5 kV
Control pollution degree	3	3
Ambient temperature	-30...50°C	-30...50°C
Non-operating temperature	-40...80°C	-40...80°C
Ambient humidity	95% r.h., non-condensing	95% r.h., non-condensing
Maintenance	Maintenance-free	Maintenance-free
Weight	2.7 kg	2.7 kg

6. ACCESSORIES FOR WKP DAMPERS

WKP-P dampers can be used as transfer dampers with use of KST type grilles with horizontal or vertical lamellas or with use of MKW flat or convex honeycomb mesh cover.

Both products are used to prevent the damper from colliding with unwanted objects, covering sensitive moving parts. Application, structure and parameters of the KST grilles are described in the documentation on the website: <https://www.smay.pl/pl/product/kratki-wentylacyjne-transferowe-kst/>

MKW mesh covers have openings similar to a honeycomb. There are two types of mesh cover (honeycomb mesh cover):

- a. MKW-B – short (flat).

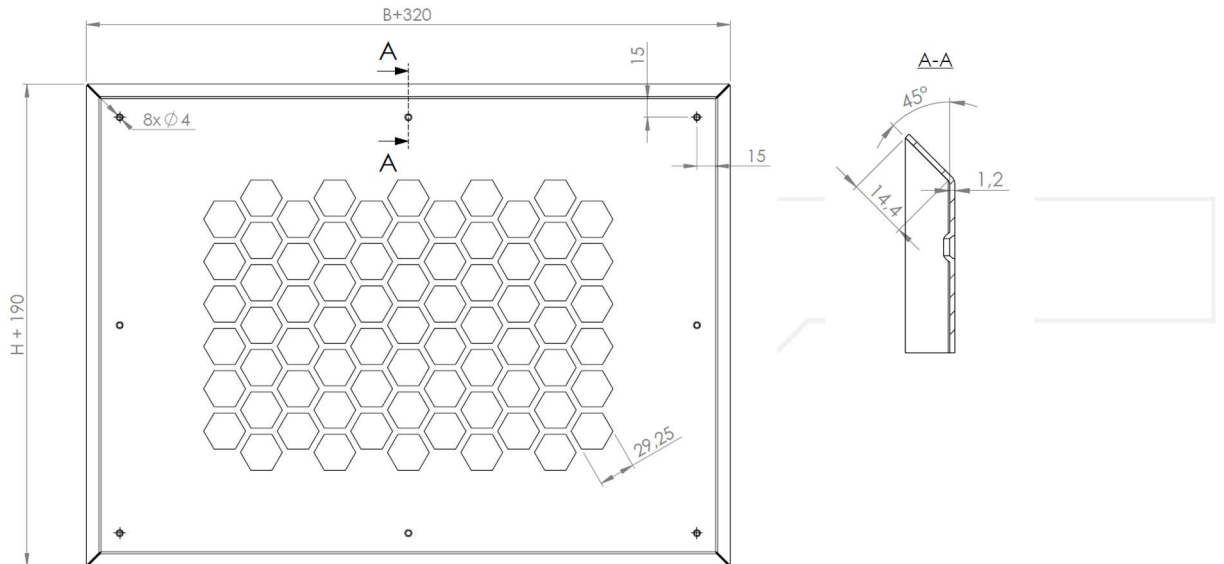

Figure 3. MKW-B (flat) honeycomb mesh cover

- b. MKW-D – tall (convex).

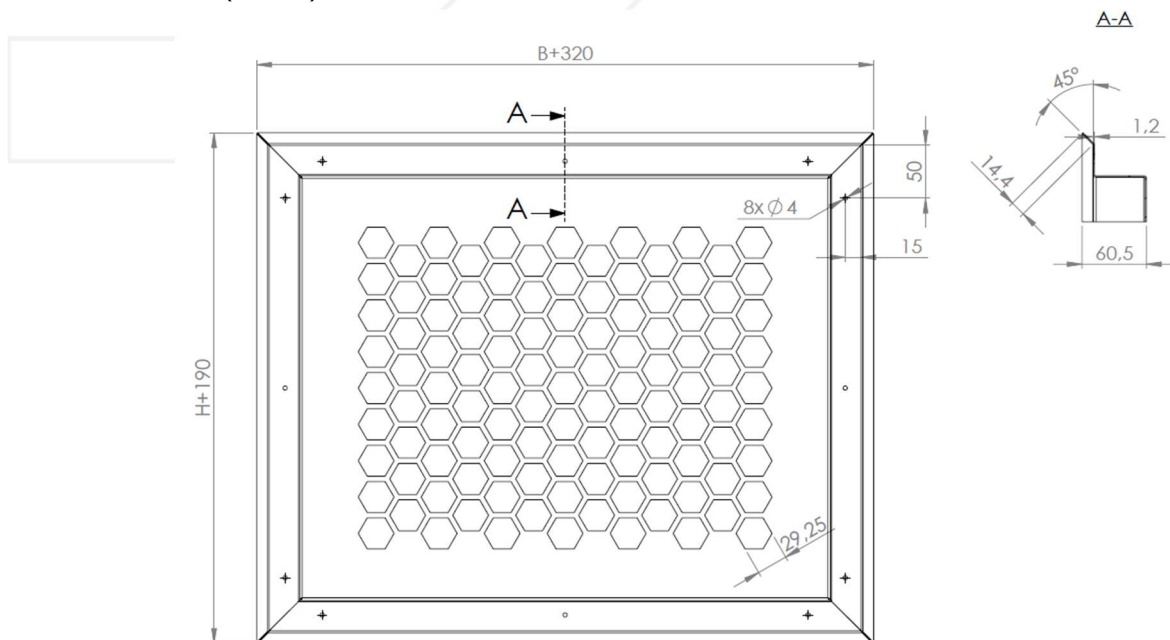

Figure 4. MKW-D (convex) honeycomb mesh cover

The honeycomb mesh cover are made in the following series of types according to their width*

B of the damper	B of the mesh cover	B of the damper	B of the mesh cover
200-250	570	701-750	1070
251-300	620	751-800	1120
301-350	670	801-850	1170
351-400	720	851-900	1220
401-450	770	901-950	1270
451-500	820	951-1000	1320
501-550	870	1001-1050	1370
551-600	920	1051-1100	1420
601-650	970	1101-1150	1470
651-700	1020	1151-1200	1520

* In a special version, the honeycomb mesh cover can be made with dimensions different from the typical ones.

7. CONDITIONS OF TRANSPORT AND STORAGE

Fire dampers WKP-P should be stored in cardboard boxes and/or on pallets. Dampers should have a pre-protected actuator cardboard box. Fire dampers should be stored indoors, providing protection against atmospheric agents, at a minimum temperature of +5°C.

Do not allow mechanical damage of damper, that may be caused e.g. blows or dropping.

During the transport the dampers should be package in cardboard, and/or put on a pallets and should be secured before relocating, and against weather conditions. Be especially careful with the WKP-P-E-W-T type dampers. After each transport, visual inspection of each fire damper must be carried out.

8. INSTALLATION TECHNOLOGY

Before installing the fire dampers, make sure that there are no damage, during transport or storage, that could block the baffle.

Check that the baffle can be opened and closed (full opening and closing position). To open fire dampers WKP-p use the actuator key.

The opening and closing must proceed smoothly (not stepwise).

Do not pull by baffle to open or close fire damper, it may cause permanent damage, not covered by the warranty.

Before installation verify dimensions of a gap between bottom blade and inner part of housing under blade, and between top blade and inner part of housing above blade. The dimension of the gap can not be lower than 4 mm.

Before installing, secure the fire damper, by dust and dirt, using a foil or other screening material. It can prevent components of fire damper by damage.

Dampers to preserve of the declared resistance, insulation and smoke leakage EIS120, EIS90, should be installed on wall, which was classified as EIS120, EIS90.

It is allowed to install WKP-P dampers in wall with other fire-resistance, should be remembered that fire-resistance in this situation is resistance of lowest classified (in this regard) element in this system.

Ducts made of flammable and non-flammable materials can be connected to the damper. Ducts should be installed that they cannot load the damper during fire. Ducts lengthening during fire can be compensated by support and knee.

ATTENTION: Distance between fire dampers or fire damper and construction elements must be compatible with standard 1366-2:

- a. Minimal 200 mm between fire damper, which are installed in different ventilating wires, and between flaps and openings in the building partition;
- b. Minimal 75 mm between fire damper and construction element (wall/ceiling).

8.1. INSTALATION TECHNOLOGY – RIGID WALL

- Make an opening in the wall 246 mm greater than the dimension B and 120 mm greater than heigh H, this is $B+246$ and $H+120$.
- For the dampers which have height $H=200$ mm and $H=300$ mm installation opening should have height $H+160$ [mm] (acceptable $140\div 180$ mm).
- Put the closed fire damper into the installation opening and support or suspend, in this way that an axis of the fire baffle matches the axis of the wall, and ensure a concentricity of fire damper and installation opening.
- After setting the fire damper as described, fill the gap between the fire damper and the wall with cement, cement-lime mortar or concrete.
- After drying of the mortar (approx. 48 hours), remove used supports or suspensions, check the fire damper correct operation and leave it in fully open position.

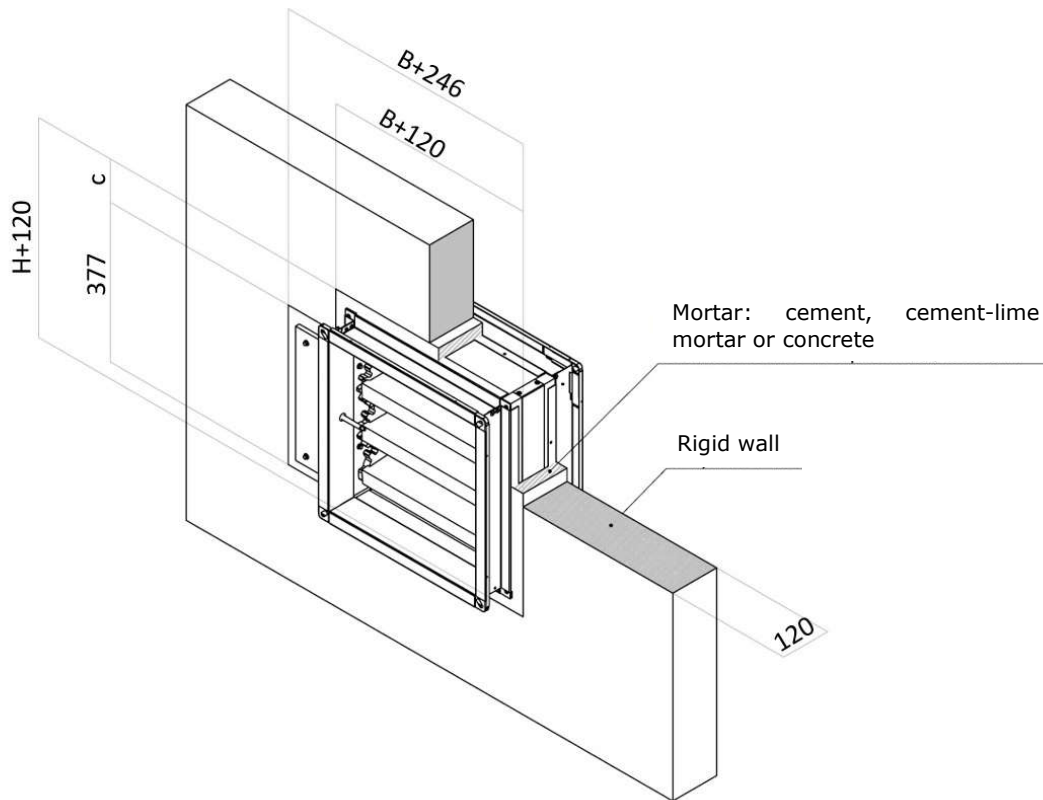

Figure 5. Dimensions of the installation opening of the WKP-P dampers in rigid wall with a horizontal and with vertical axis of rotation of the baffle. The C dimension is given in the table.

H	C
200	0
300	100
400	100
500	200
600	200
700	300
800	300

H – nominal height of the damper

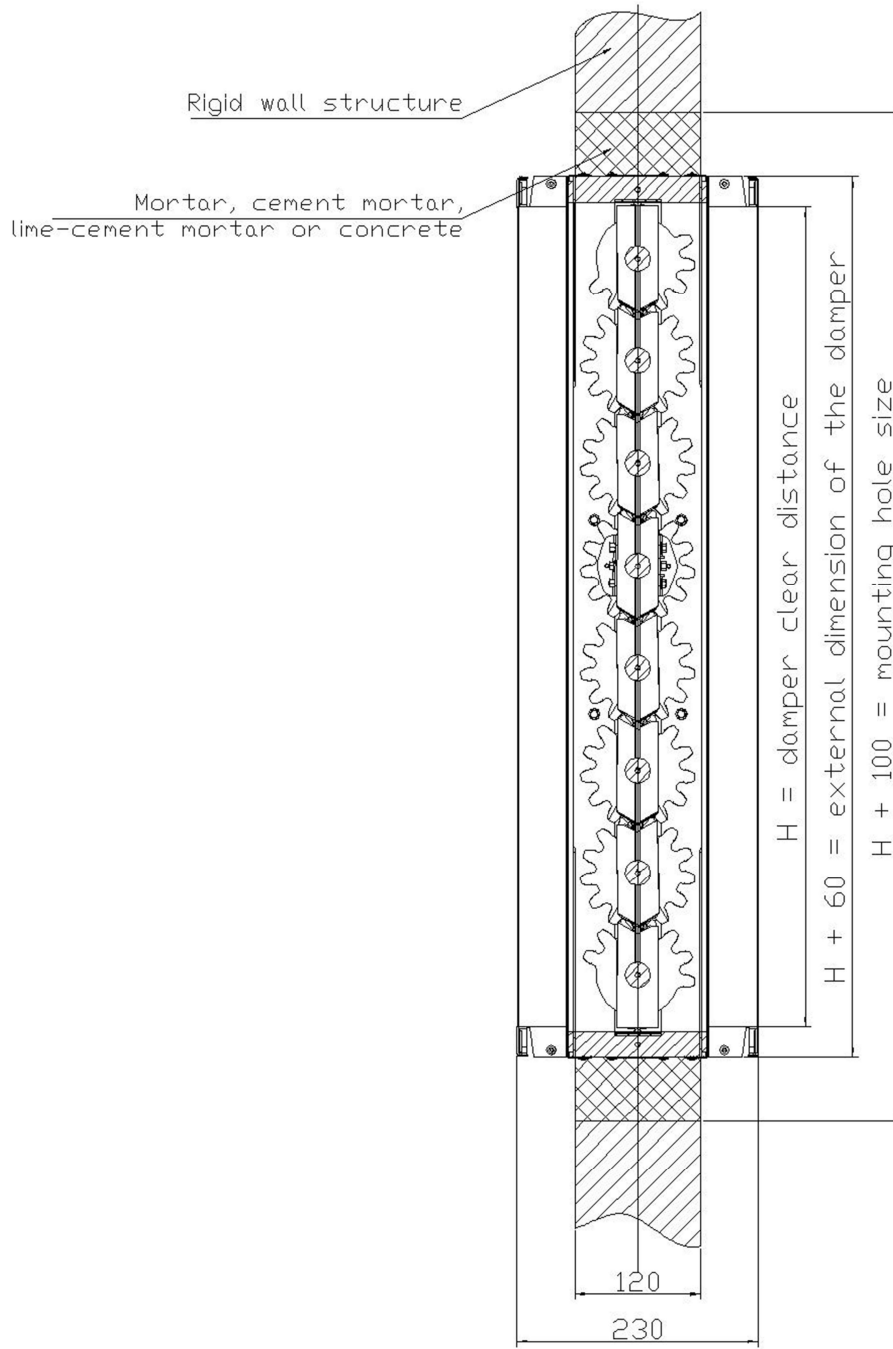

Figure 6. Installing method of WKP-P fire dampers in rigid wall, baffle axis should be in line with wall axis

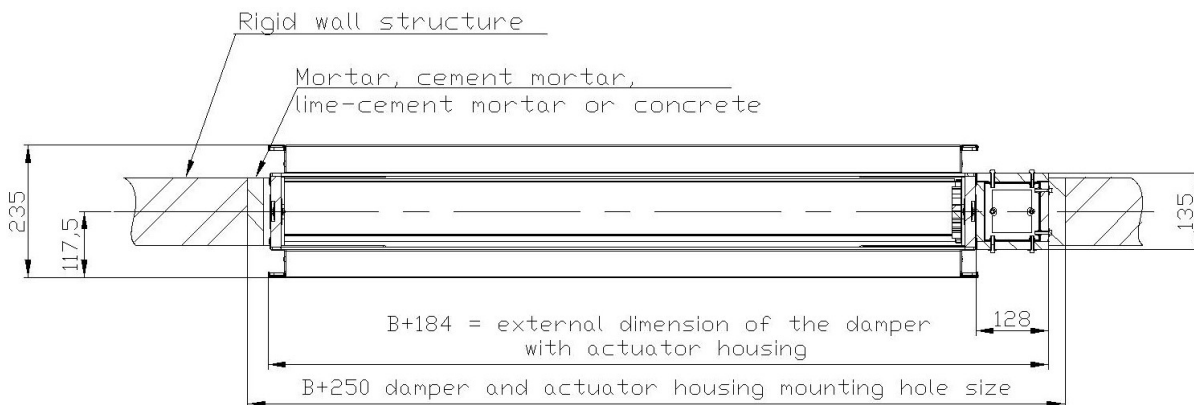

Figure 7. Installing method of WKP-P fire dampers in rigid wall, baffle axis should be in line with wall axis

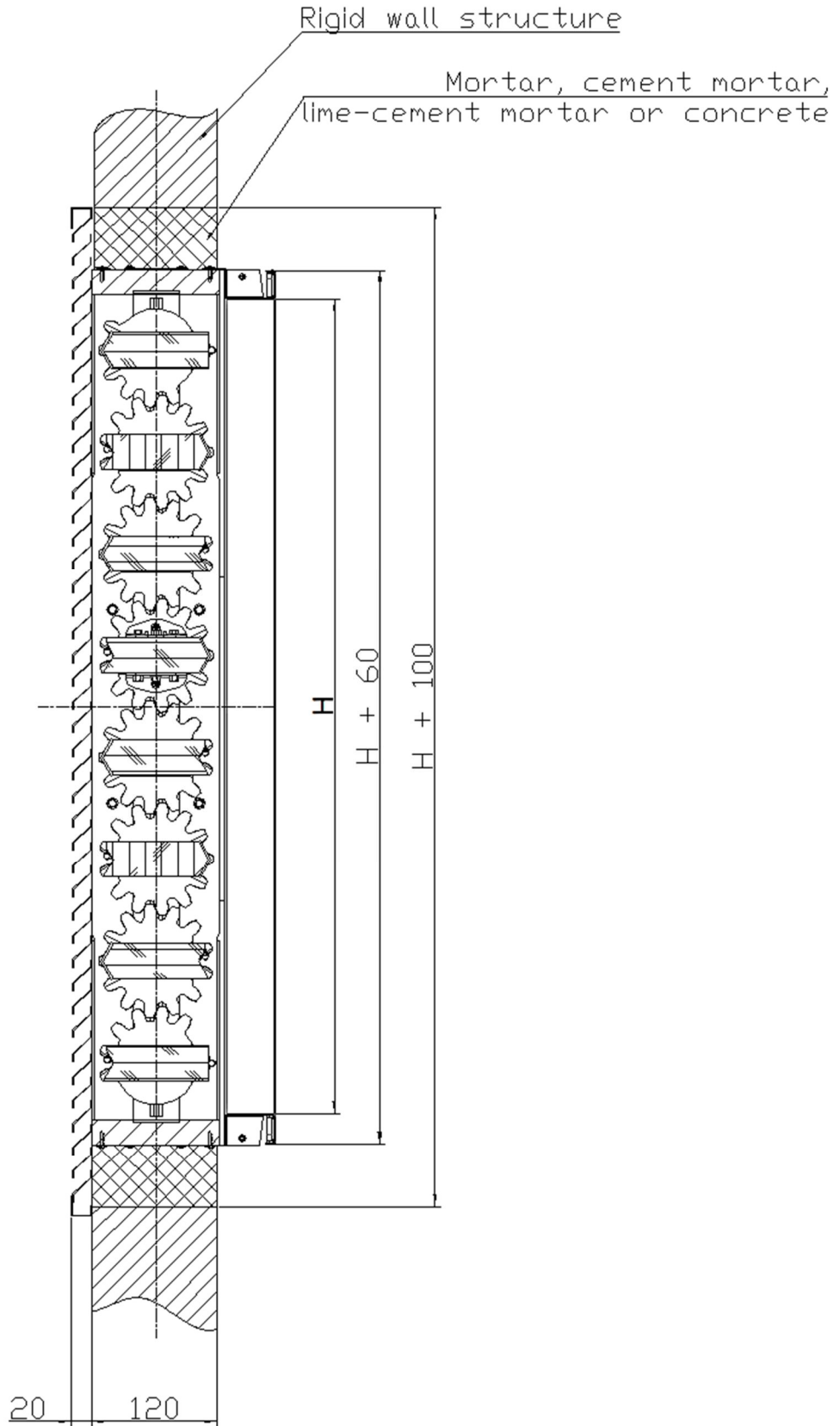

Figure 8. Installing method of WKP-P fire dampers in rigid wall

8.1.1. PROMADUCT

After setting the fire damper as described, and build it in wall, duct made of PROMATECT-L500 boards with 50 mm thickness must be installed. The band around the duct must be made by PROMATECT-L500, with 50 mm thickness and 60 mm width. Connection of damper and the wall, and damper with the band must be made by K84 glue. The sides of the duct and the band must be connected by using 4,2x90 – 4,8x120 screws.

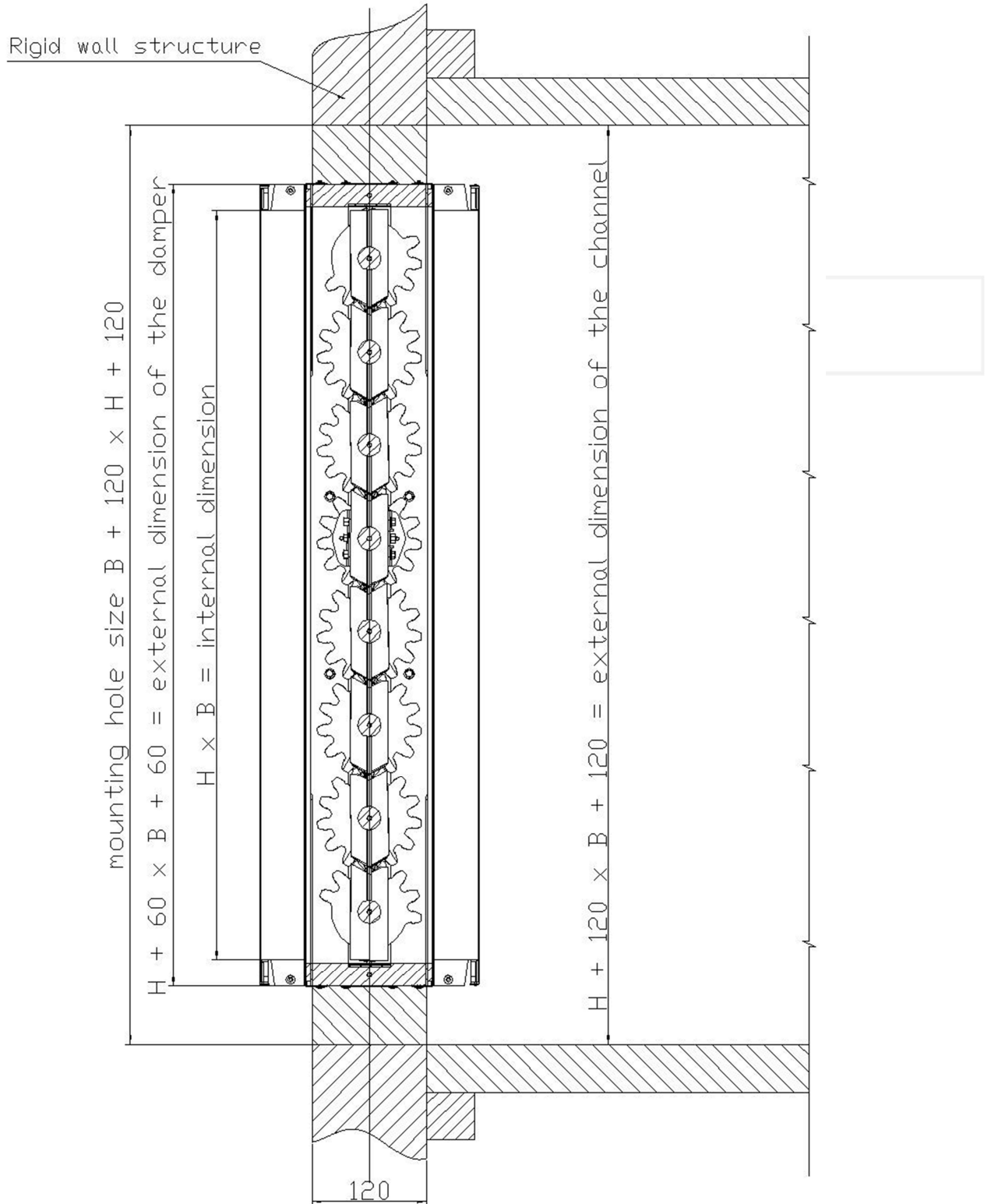

Figure 8. Installing method of WKP-P fire dampers with PROMAT boards duct

8.2. INSTALLATION TECHNOLOGY – STRUCTURES THICKER THAN 125 mm

In rigid walls, with thickness less than or equal to 125 mm, WKP-P fire dampers are installed in this way that an axis of the fire baffle matches the axis of the wall, and ensure a concentricity of fire damper and installation opening.

In case when wall have more than 125 mm thickness: WKP-P fire dampers are installed in this way that the damper border is flush with the wall surface (Fig. 9).

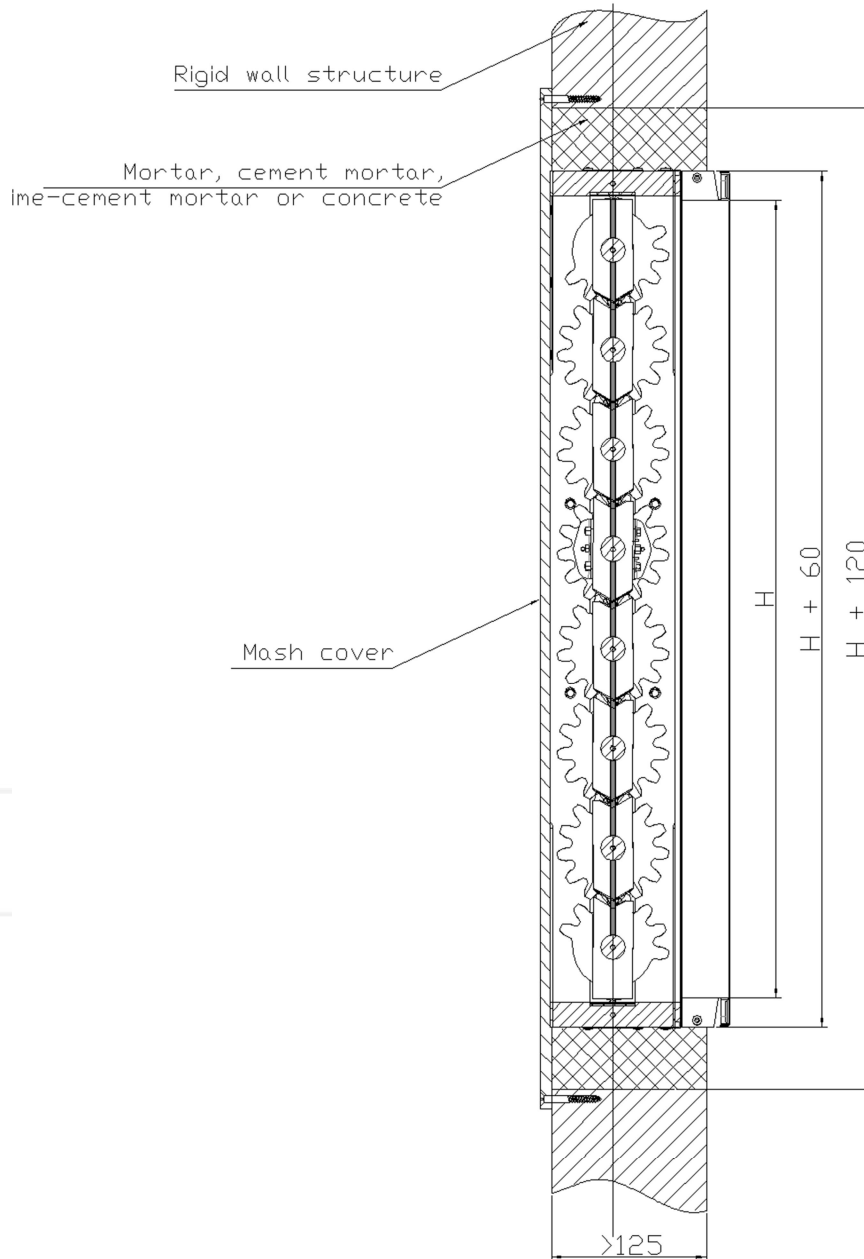

Figure 9. Installation method of fire dampers WKP-P in structures thicker than 125 mm

8.3. INSTALLATION TECHNOLOGY – FLEXIBLE WALL WITH 125mm THICKNESS

- Make an opening in the wall with the dimensions 310 mm greater than the width B and 180 mm greater than the height H: this is $B+310$ and $H+180$.
- For the dampers which have height $H=200$ mm and $H=300$ mm installation opening should have height $H+160$ mm (acceptable $140\div 180$ mm).
- Make a frame of two layers of GKF boards 15 mm thick and a width corresponding to the installation opening screwed tightly, bearing in mind the exact sealing at their joints by using Hilti Firestop Coating CP 673, Promastop CC liquid, Promaseal-Mastic or Soudal Firesilicone B1 FR.
- Put the closed fire damper into the installation opening and support or suspend, in this way that an axis of the fire baffle matches the axis of the wall, and ensure a concentricity of fire damper and installation opening.
- After setting the fire damper as described, fill the gap between the fire damper and the wall with non-flammable mineral wool of high density, 100 kg/m³ or more.
- Seal the place of filling with mineral wool using the sealing mass given in pts.2
- Mount the collar, of GKF boards on both side of wall, with a thickness of 15 mm and a width of 150 mm, with the screws.
- After mounting the collar, remove the supports or suspensions, check the fire damper correct operation and leave it in open position.

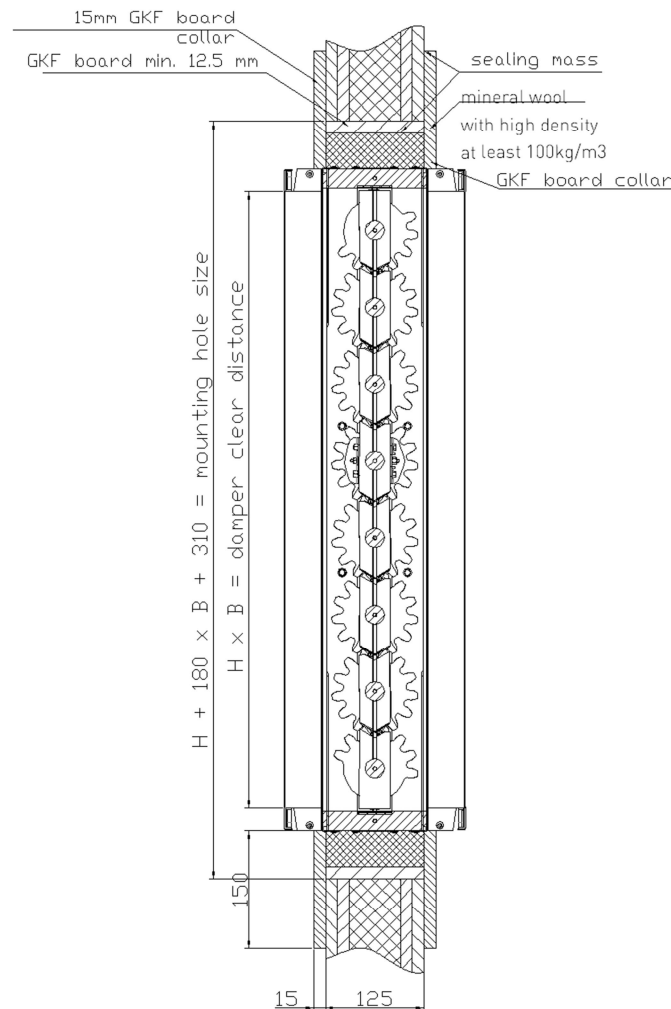

Figure 10. Installation method of fire dampers WKP-P in flexible wall with 125 mm thick

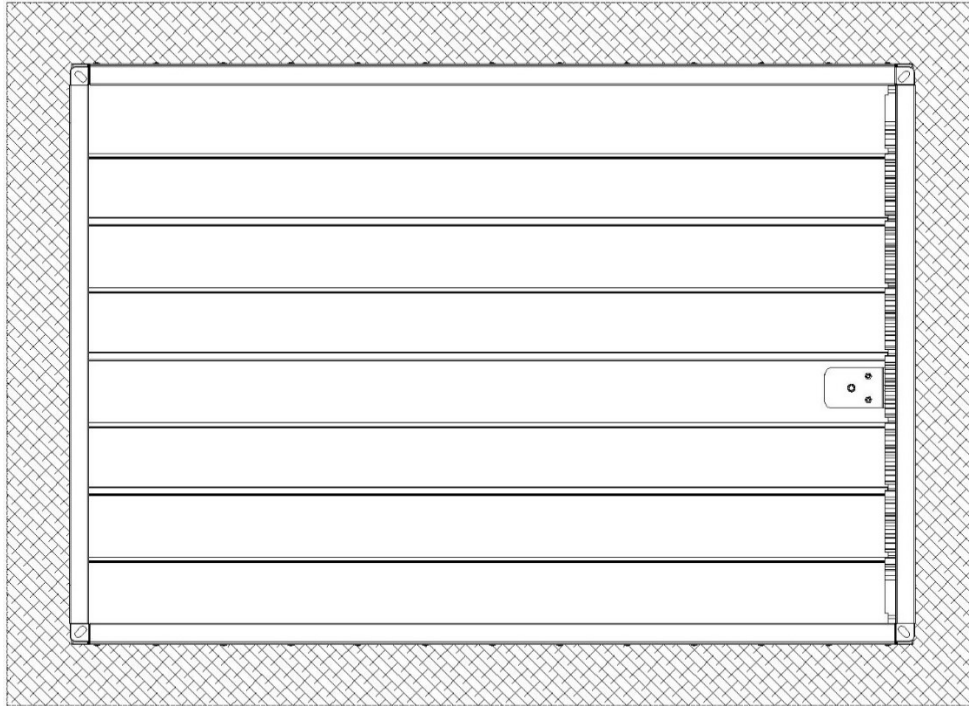

Figure 11. Installation method of fire dampers WKP-P in flexible wall

8.4. INSTALLATION TECHNOLOGY – MKW HONEYCOMB MESH COVER AND KST GRILLE

- Before installing honeycomb mesh cover, it is necessary to stick 5x10 self-adhesive ceramic gasket, on inside surface of mesh cover, along the deflection, around the perimeter.
- Honeycomb mesh cover install to the wall with use metal pins for gas-concrete 6x32 and with use 5x40 screws.
- Honeycomb mesh cover install in this way as shown in the figure below. Outer edges of openings on left side of mesh cover as well on a top and on a bottom must be in line with inside edges of the damper.

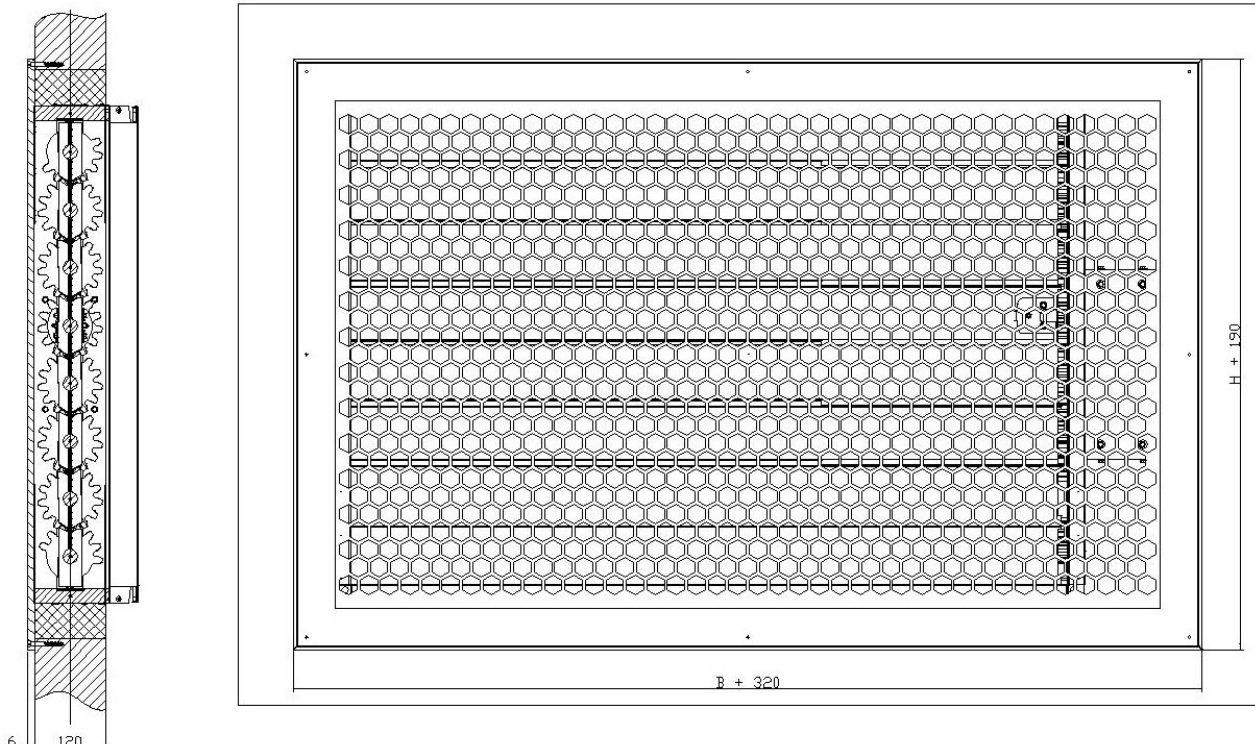

Figure 12. Installation method of MKW-B honeycomb mesh cover

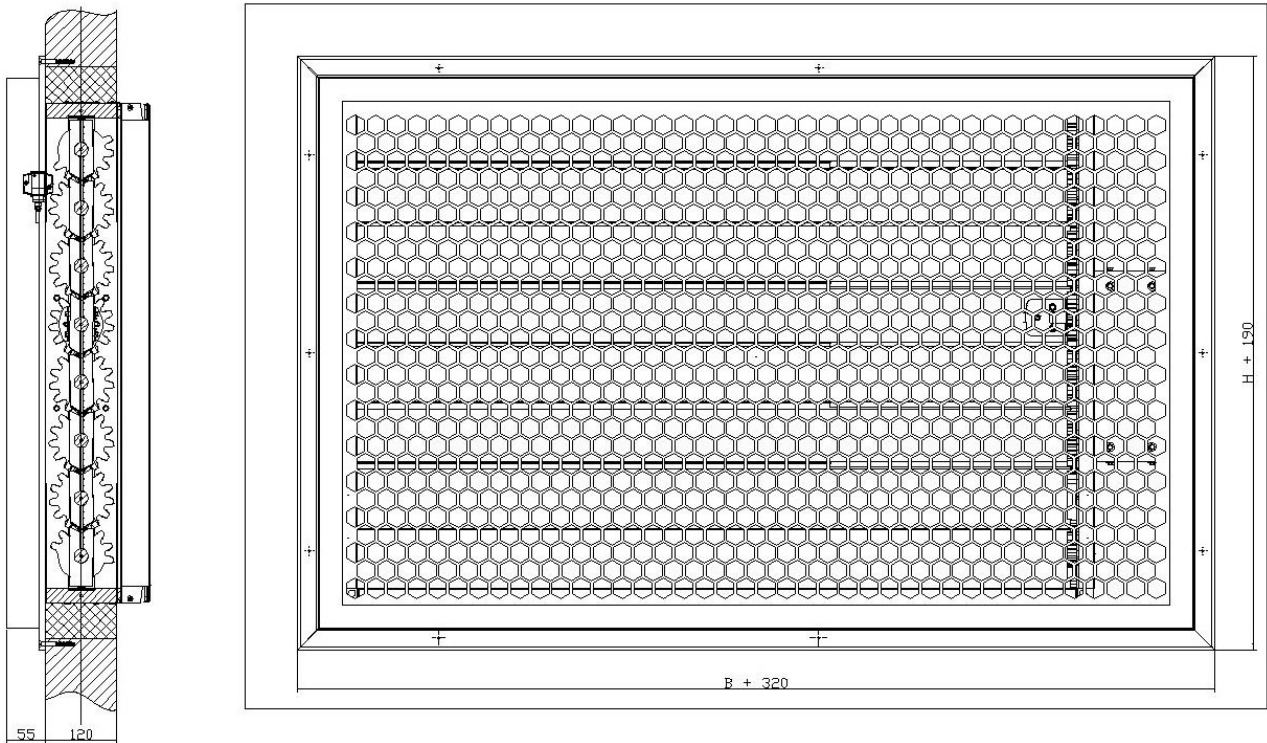

Figure 13. Installation method of MKW-D honeycomb mesh cover

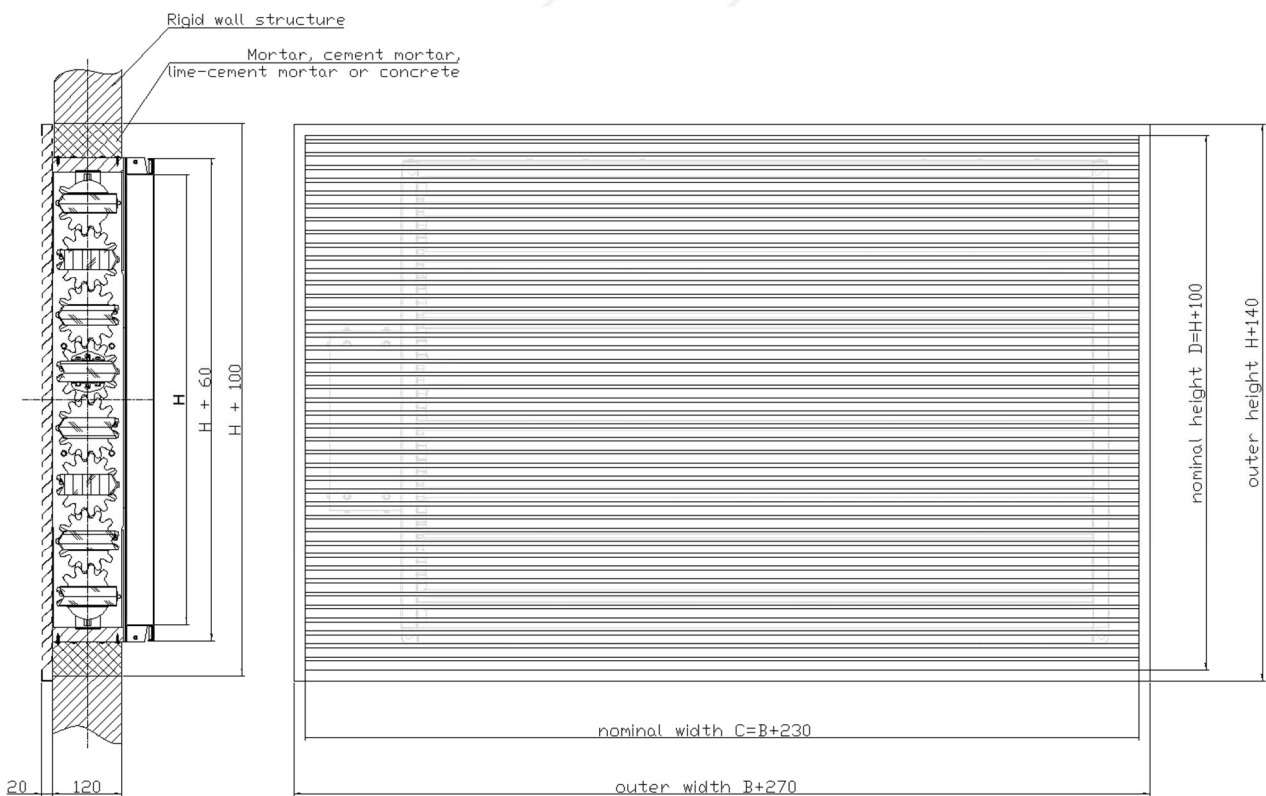

Figure 14. Installation method of KST grille

9. COMMISSIONING

After assembling the device and installation into the control system, before putting the smoke control damper into operation, the following actions should be carried out and recorded:

- verify the correct assembly of the damper according to this Technical Documentation;
- check the correctness of the electrical installation in terms of power supply parameters and quality of execution;
- ensure that the damper has not been mechanically damaged during installation;
- verify the correct opening/closing of the damper, with the opening/closing time being maintained below 60 seconds;
- check the cleanliness of the device and ensure that there are no foreign elements present that could damage the device;
- ensure proper accessibility to the drive mechanism and thermal trigger mechanism - required for service and maintenance purposes;
- check the availability and legibility of labeling stickers.

After the installation of the WKP-P damper, before putting it into operation, a document must be prepared: 'Installation and Commissioning Protocol - Smoke control dampers'. This protocol should be signed by a person holding a current, personalized certificate or certificate issued by Smay Sp. z o. o. authorizing the installation of WKP-P dampers. A copy of this document should be sent electronically to the manufacturer (www.smay.pl → SERVICE AND WARRANTY tab → ADD START-UP PROTOCOL) within 30 days from the commissioning date (date indicated in the Installation and Commissioning Protocol for the WKP-P damper). Failure to comply with this formality will result in the loss of warranty for the device.

Installation and Commissioning Protocol - Smoke control dampers (universal for all dampers in the SMAY offer) is outlined below:



INSTALLATION AND COMMISSIONING PROTOCOL - SMOKE CONTROL DAMPERS

<p>Data of the company performing the installation and commissioning (seal)</p>	<p>Device manufacturer</p>
--	-----------------------------------

OBJECT / INSTALLATION LOCATION	INSTALLATION AND COMMISSIONING EXECUTION
---------------------------------------	---

Object Name: Object Address:	<table border="1" style="width:100%; border-collapse: collapse;"> <tr> <td style="width:30%; padding: 5px; vertical-align: middle;"> Damper Type: </td> <td style="padding: 5px;"> <input type="checkbox"/> KTM-O <input type="checkbox"/> KTS-O <input type="checkbox"/> KWP-O <input type="checkbox"/> KWP-P <input type="checkbox"/> KWP-Ex <input type="checkbox"/> KWP-L <input type="checkbox"/> WKP-O <input type="checkbox"/> WKP-P <input type="checkbox"/> WKZ-O <input type="checkbox"/> WKS-P </td> </tr> <tr> <td style="padding: 5px; vertical-align: middle;"> Commissioning Date </td> <td style="padding: 5px;"> </td> </tr> </table>	Damper Type:	<input type="checkbox"/> KTM-O <input type="checkbox"/> KTS-O <input type="checkbox"/> KWP-O <input type="checkbox"/> KWP-P <input type="checkbox"/> KWP-Ex <input type="checkbox"/> KWP-L <input type="checkbox"/> WKP-O <input type="checkbox"/> WKP-P <input type="checkbox"/> WKZ-O <input type="checkbox"/> WKS-P	Commissioning Date
Damper Type:	<input type="checkbox"/> KTM-O <input type="checkbox"/> KTS-O <input type="checkbox"/> KWP-O <input type="checkbox"/> KWP-P <input type="checkbox"/> KWP-Ex <input type="checkbox"/> KWP-L <input type="checkbox"/> WKP-O <input type="checkbox"/> WKP-P <input type="checkbox"/> WKZ-O <input type="checkbox"/> WKS-P				
Commissioning Date				

SCOPE OF CONTROL AFTER INSTALLATION AND COMMISSIONING

- A** - Correctness of damper assembly according to the Technical Documentation Record (DTR);
- B** - Correctness of the electrical installation in terms of power supply parameters and quality of execution;
- C** - Damper has not been mechanically damaged during installation;
- D** - Correct opening/closing of the damper, with the opening/closing time being maintained below 60 seconds;
- E** - Cleanliness of the device, and absence of foreign elements that could lead to device damage;
- F** - Maintenance of proper accessibility to the drive mechanism and thermal trigger - required for service and maintenance purposes;
- G** - Availability and legibility of labeling stickers.

N – negative result
P – positive result

DAMPERS	CHECKLIST OF ACTIVITIES
----------------	--------------------------------

No.	Identification	Type	Serial Number	A		B		C		D		E		F		G	
				P	N	P	N	P	N	P	N	P	N	P	N	P	N
1																	
2																	
3																	
4																	
5																	
6																	
7																	
8																	
9																	
10																	
11																	

12																	
13																	
14																	
15																	
16																	
17																	
18																	
19																	
20																	

Remarks:

.....

.....

.....

.....

.....

.....

.....

.....

.....

.....

Contractor's Declaration

We confirm the execution of the protocol in accordance with the guidelines and Technical Documentation of the manufacturer and the manufacturer's instructions from the assembly manual.

Control Result: **Positive / Negative**

Recommendations: None / as per the
 remarks above

Review Contractor		Authorization Number <small>(issued by Smay company)</small>	Signature	Client Confirmation:
1.				
2.				

10. PERIODIC MAINTENANCE AND SERVICING RULES

Before starting any operational and maintenance work, you must familiarize yourself with this documentation. This obligation particularly falls on individuals responsible for operating the device or equipment within the scope of operation, maintenance, and service. In the absence of technical personnel with qualifications specified by the manufacturer, the inspection/maintenance of current devices should be carried out by the SMAY Manufacturer's Service or an Authorized SMAY Service/SMAY Service Partner.

Damage to the WKP-P damper resulting from failure to comply with the guidelines contained in the documentation will not be covered by warranty repairs.

After installing WKP-P smoke control dampers and with the system activated, it is necessary to conduct regular inspections and record them as presented in the Annual Inspection Protocol - Smoke control dampers (included below) **no less frequently than every 12 months or in periods resulting from local legislation. If necessary, inspections should be conducted more frequently.**

The fact of inspecting the technical condition and servicing of the device should be documented by an inspection protocol, the template of which has been included in this documentation.

Failure to implement the above guidelines regarding periodic inspection results in the device not being allowed for further operation. Simultaneously such a device loses the manufacturer's warranty protection in accordance with the OWG

All activities related to the replacement or modification of device components can only be carried out by the SMAY Manufacturer's Service or an Authorized SMAY Service/SMAY Service Partner. Elements that have been factory sealed should have intact original seals applied by the SMAY Manufacturer's Service or an Authorized SMAY Service/SMAY Service Partner.

The WKP-P damper does not require any protective measures other than regular maintenance/technical inspections and proper care, including keeping the damper elements clean. The damper can be cleaned using a dry cloth or brush. Dirt and other contaminants can be removed using commonly available cleaning agents. Do not use aggressive, corrosive, or sharp tools.

Below is a list of recommended periodic inspection activities along with possible faults (universal for all dampers in the SMAY offer).



ANNUAL INSPECTION PROTOCOL - SMOKE CONTROL DAMPERS			
Company performing the inspection (seal)		Device manufacturer	
OBJECT / INSTALLATION LOCATION		INSPECTION EXECUTION	
Nazwa obiektu:		Date of execution:
Adres obiektu:		Subject of review / Damper type:	<input type="checkbox"/> KTM-O <input type="checkbox"/> KTS-O <input type="checkbox"/> KWP-O <input type="checkbox"/> KWP-P <input type="checkbox"/> KWP-Ex <input type="checkbox"/> KWP-L <input type="checkbox"/> WKP-O <input type="checkbox"/> WKP-P <input type="checkbox"/> WKZ-O <input type="checkbox"/> WKS-P
.....		Total number of devices:
SCOPE OF THE REVIEW PERFORMED			
Inspection activities <small>(in accordance with the attachment)</small>		Status of inspection activities	
		Performed <small>(Yes/No)</small>	Evaluation <small>(Positive/Negative)</small>
		Issue number <small>(Describe below on the page)</small>	
1	Visual inspection of dampers		
2	Control of damper actuator		
3	Trigger inspection		
4	Inspection of smoke control damper operation		
5	Leaving dampers in operational position		
A detailed list of devices subjected to inspection is presented in Attachment No. 1: 'List of Devices,' which is an integral part of this inspection protocol.			
REMARKS / RECOMMENDATIONS <small>(enumerate from consecutive numbers)</small>			
.....			

.....

.....

.....

.....

.....

.....

.....

.....

.....

.....

.....

.....

.....

.....

.....

.....

.....

.....

.....

.....

.....

.....

Contractor's Statement

We confirm the execution of the inspection in accordance with the guidelines and manufacturer's technical documentation. Based on the aforementioned regulation, we inform about the obligation to perform annual inspections of smoke control dampers as part of the fire protection system.

Result of the **Positive / Negative**
inspection:

Recommendations: None / as per remarks
above

The next inspection should be performed before 20..... r.
(Month)

Inspection contractor		License number (issued by Smay company)	Signature	Confirmation by the Client:
1.				
2.				

Checklist of activities:		Legend for remarks: Remarks with the symbol (K) denote critical remarks that result in a negative control outcome for the damper.
A.	Reading data from the nameplate sticker of the damper	1. (K) lack of access to the damper for inspection; 2. absence of a visible nameplate sticker; 3. illegible data on the sticker;
B.	Assessment of the condition of the damper enclosure	4. (K) absence or severely damaged enclosure of the damper in the wall; absence or severely damaged fire insulation of the damper installed on the duct; 5. minor damage to the damper enclosure or suspicion of enclosure not compliant with manufacturer's guidelines;
C.	Assessment of the condition of the damper casing	6. damage to casing, perforation, bending, corrosion;
D.	Assessment of the condition of the partition and drive transmission	7. (K) lack of access to inspect the inside of the damper; 8. (K) damage to the partition or gears*, cracking, delamination; 9. (K) damage to the partition bearings or drive transmission mechanisms;
E.	Assessment of the condition of the swelling seal and ventilation	10. (K) damage to the swelling seal, noticeable loss, lack of continuity around the partition; 11. damage to the ventilation seal, noticeable loss, detachment from the mounting location;
F.	Assessment of damper cleanliness, cleaning	12. (K) severe soiling of damper components impossible to remove;
G.	Assessment of manual mechanism*	13. (K) damage to manual mechanism (e.g., rotating or loose spring); 14. lack of indication of damper position status;
H.	Assessment of the actuator* (compliance of the symbol with the nameplate, warranty seal)	15. (K) lack of actuator response to power supply; 16. (K) actuator spring damage; 17. (K) actuator symbol not matching the nameplate; 18. warranty seal broken; 19. noticeable mechanical damage to actuator; 20. lack of service access to actuator; 21. improper manual actuation of the actuator;
I.	Assessment of damper electrical connection*	22. (K) damage to power supply cable; 23. lack of access to junction box;
J.	Inspection of mechanical trigger*	24. (K) lack of a fusible link element; 25. (K) non-factory method of holding the damper in the open position; 26. (K) trigger embedded in the wall;
K.	Inspection of electrical trigger*	27. (K) lack of response to pressing the test button on the trigger; 28. (K) unscrewed or improperly mounted trigger; 29. trigger embedded in the wall;
L.	Opening and closing of the damper	30. (K) inability to fully transition the partition from closed to open position and vice versa; 31. (K) rubbing of the partition against the enclosure during position change;
M.	Assessment of maintaining the open position	32. lack of damper retention in the open position;
N.	Assessment of proper closure of the damper	33. (K) lack of full closure of the partition;
O.	Assessment of proper response to control signal from SAP or voltage loss	34. lack of or improper response to control signal; 35. (K) no response to power loss (applies to shut-off dampers); 36. (K) operation not in accordance with control matrix (applies to fire ventilation dampers); 37. lack of feedback on damper status to SAP;
		99. Other

* If they occur in the controlled type of damper

No.	Dampers			Power supply voltage [V]	Visual inspection of the damper (A-F)		Damper actuator check (G-I)		Trigger control check (J-K)		Damper operation check (L-O)		Location	Remarks
	Labeling	Type	Serial number		Positive	Negative	Positive	Negative	Positive	Negative	Positive	Negative		
					<input type="checkbox"/>	<input type="checkbox"/>	<input type="checkbox"/>	<input type="checkbox"/>	<input type="checkbox"/>	<input type="checkbox"/>	<input type="checkbox"/>	<input type="checkbox"/>		
					<input type="checkbox"/>	<input type="checkbox"/>	<input type="checkbox"/>	<input type="checkbox"/>	<input type="checkbox"/>	<input type="checkbox"/>	<input type="checkbox"/>	<input type="checkbox"/>		
					<input type="checkbox"/>	<input type="checkbox"/>	<input type="checkbox"/>	<input type="checkbox"/>	<input type="checkbox"/>	<input type="checkbox"/>	<input type="checkbox"/>	<input type="checkbox"/>		
					<input type="checkbox"/>	<input type="checkbox"/>	<input type="checkbox"/>	<input type="checkbox"/>	<input type="checkbox"/>	<input type="checkbox"/>	<input type="checkbox"/>	<input type="checkbox"/>		
					<input type="checkbox"/>	<input type="checkbox"/>	<input type="checkbox"/>	<input type="checkbox"/>	<input type="checkbox"/>	<input type="checkbox"/>	<input type="checkbox"/>	<input type="checkbox"/>		
					<input type="checkbox"/>	<input type="checkbox"/>	<input type="checkbox"/>	<input type="checkbox"/>	<input type="checkbox"/>	<input type="checkbox"/>	<input type="checkbox"/>	<input type="checkbox"/>		
					<input type="checkbox"/>	<input type="checkbox"/>	<input type="checkbox"/>	<input type="checkbox"/>	<input type="checkbox"/>	<input type="checkbox"/>	<input type="checkbox"/>	<input type="checkbox"/>		
					<input type="checkbox"/>	<input type="checkbox"/>	<input type="checkbox"/>	<input type="checkbox"/>	<input type="checkbox"/>	<input type="checkbox"/>	<input type="checkbox"/>	<input type="checkbox"/>		
					<input type="checkbox"/>	<input type="checkbox"/>	<input type="checkbox"/>	<input type="checkbox"/>	<input type="checkbox"/>	<input type="checkbox"/>	<input type="checkbox"/>	<input type="checkbox"/>		
					<input type="checkbox"/>	<input type="checkbox"/>	<input type="checkbox"/>	<input type="checkbox"/>	<input type="checkbox"/>	<input type="checkbox"/>	<input type="checkbox"/>	<input type="checkbox"/>		
					<input type="checkbox"/>	<input type="checkbox"/>	<input type="checkbox"/>	<input type="checkbox"/>	<input type="checkbox"/>	<input type="checkbox"/>	<input type="checkbox"/>	<input type="checkbox"/>		
					<input type="checkbox"/>	<input type="checkbox"/>	<input type="checkbox"/>	<input type="checkbox"/>	<input type="checkbox"/>	<input type="checkbox"/>	<input type="checkbox"/>	<input type="checkbox"/>		
					<input type="checkbox"/>	<input type="checkbox"/>	<input type="checkbox"/>	<input type="checkbox"/>	<input type="checkbox"/>	<input type="checkbox"/>	<input type="checkbox"/>	<input type="checkbox"/>		
					<input type="checkbox"/>	<input type="checkbox"/>	<input type="checkbox"/>	<input type="checkbox"/>	<input type="checkbox"/>	<input type="checkbox"/>	<input type="checkbox"/>	<input type="checkbox"/>		
					<input type="checkbox"/>	<input type="checkbox"/>	<input type="checkbox"/>	<input type="checkbox"/>	<input type="checkbox"/>	<input type="checkbox"/>	<input type="checkbox"/>	<input type="checkbox"/>		
					<input type="checkbox"/>	<input type="checkbox"/>	<input type="checkbox"/>	<input type="checkbox"/>	<input type="checkbox"/>	<input type="checkbox"/>	<input type="checkbox"/>	<input type="checkbox"/>		
					<input type="checkbox"/>	<input type="checkbox"/>	<input type="checkbox"/>	<input type="checkbox"/>	<input type="checkbox"/>	<input type="checkbox"/>	<input type="checkbox"/>	<input type="checkbox"/>		
					<input type="checkbox"/>	<input type="checkbox"/>	<input type="checkbox"/>	<input type="checkbox"/>	<input type="checkbox"/>	<input type="checkbox"/>	<input type="checkbox"/>	<input type="checkbox"/>		
					<input type="checkbox"/>	<input type="checkbox"/>	<input type="checkbox"/>	<input type="checkbox"/>	<input type="checkbox"/>	<input type="checkbox"/>	<input type="checkbox"/>	<input type="checkbox"/>		

11. CLASSIFICATION OF DAMPERS FOR REPAIR

The authorized service personnel of the manufacturer or trained companies authorized by them are responsible for removing any detected damages during the periodic inspection. In case of malfunction or damage, the user is obliged to notify the manufacturer or an authorized service company.

After each activation of the damper as a result of a fire action at the facility, it is necessary to assess its technical condition, and consequently qualify it for repair or replacement with a new one. The assessment can only be carried out by the manufacturer's service personnel. Repair work or replacement of the damper after activation due to a fire action at the facility is not covered by the warranty.

12. WARRANTY CONDITIONS

The manufacturer provides a warranty for the delivered products, on the terms set forth in the Agreement or the General Warranty Conditions of Smay, Sp. z o.o. The warranty does not cover defects resulting from improper storage, transportation, installation, and commissioning, operation, periodic maintenance, service, especially mechanical damage and damage to anti-corrosive coatings.

The manufacturer is exempt from warranty obligations if the user introduces structural changes independently, installs the product by the purchaser contrary to the Installation Instructions and Technical Conditions of Sale (DTR), exceeds the declared durability of the damper, defects due to improper periodic maintenance, and when there is permanent removal of the product nameplate or lack of legibility and verification of the device type.

The General Warranty Conditions (OWG) and General Sales Conditions (OWS) documents are available on the website www.smay.pl



ATTENTION!

Installation and Commissioning Protocol - Fire Dampers:

- **The protocol should be signed by a person holding a valid, personalized certificate or authorization issued by Smay Sp. z o. o., authorizing the installation of fire dampers.**
- **A copy of this document must be sent to the manufacturer electronically (www.smay.pl → SERVICE AND WARRANTY tab → ADD COMMISSIONING PROTOCOL).**
- **A copy of this document must be sent within 30 days from the date of commissioning (date specified in the Installation and Commissioning Protocol - Fire Dampers).**

The template of the Installation and Commissioning Protocol - Fire Dampers is available in the Technical Documentation



ATTENTION!

Annual Inspection Protocol - Fire Dampers:

- **The protocol should be signed by a person holding a valid, personalized certificate or authorization issued by Smay Sp. z o. o., authorizing inspections of fire dampers.**
- **In order to maintain the warranty, the employee conducting inspections of SMAY fire dampers is required, upon completion of such inspection, to submit the Annual Inspection Protocol to the manufacturer electronically (www.smay.pl → SERVICE AND WARRANTY tab → ADD COMMISSIONING PROTOCOL)**

The template of the Annual Inspection Protocol - Fire Dampers is located at the end of the Technical Documentation.

**ATTENTION!**

The templates of forms attached to this Technical Documentation (related to installation, commissioning, inspections) are the intellectual property of Smay sp. z o.o. Copying, duplicating, and using them for purposes other than those specified in this Technical and Operating Documentation is prohibited. To maintain the warranty, it is required to fill them out and deliver them to SMAY sp. z o.o. within 30 days from the date of installation/commissioning and inspection (other forms will not be accepted).