

ZODIC-M

SMOKE AND HEAT EXTRACTION SET – MECHANICAL



Specification:

ZODIC-M set is a complete system of smoke extraction from staircases, with variable mechanical compensation air-supply.

Intended use

ZODIC-M is a complete set of products for smoke and heat extraction from staircases, which improves the conditions for conducting fire extinguishing and rescue actions. It also increases the safety of people and enables their conditional evacuation. The main task of the ZODIC-M product set is generating the forced flow of air and smoke in the staircase, enabling smoke extraction and preventing smoke dropping below the storey where fire started. Air and smoke flowing through the smoke extraction device is monitored on a continuous basis and the amount of compensation air is adjusted depending on the actual flow. An additional function of the ZODIC-M set is the possibility of ventilating the staircase.

Operating rule

The system may be activated automatically by smoke and heat detectors or manual alarming with the use of manual smoke extraction push buttons or through the signal received from the Fire Alarm System(FAS).

After smoke detection, the SCD-1-L smoke and heat vent, which is placed in the roof/upper part of the staircase or the CDH-F-L wall smoke and heat vent is opened, and the compensation air-supply is activated which operates with variable efficiency.

The acoustic/optical signalling device of fire hazard may be activated optionally. If there are electric holders mounted in the building, they are released and it is possible to close the door separating fire zones.

ZODIC-M monitors the speed of gas flowing through the smoke extraction device. It adjusts the supply of compensation air fed to the staircase space in a continuous and smooth manner. The variable forced flow results in the effective removal of the smoke and air mixture from the staircase, and it ensures the effective smoke removal from the staircase, preventing smoke from dropping below the storey which is on fire. A compensation fan controlled by means of an inverter increases efficiency when opening the door during evacuation and it decreases efficiency when smoke force raises the pressure excessively in the staircase.

Technical data

Table 1. Technical data.

Power supply voltage	3x400VAC, N, PE
Power supply voltage frequency	50 Hz
Nominal active power, Current consumption from the network	Depending on the Power Supply and the Control Module and the set configuration
IP rating of smoke extraction control unit	IP54
Group/zone configuration	<ul style="list-style-type: none"> • 1 smoke extraction group as a standard (max. 9) • 1 ventilation group as a standard (max. 9)
Supervision lines / smoke detector inputs	<ul style="list-style-type: none"> • Conventional, parametric, open • 2 lines as a standard (max. 36) • Max. 32 smoke detectors on one supervision line
The lines of the manual push buttons of smoke extraction	<ul style="list-style-type: none"> • 2 lines as a standard (max. 18) • It is possible to connect max. 10 manual smoke extraction push buttons per one line
Actuator outputs	For the ZODIC-M set elements as a standard. Optionally, for supplying the smoke and heat distribution control system elements with power.
Functionality	<ul style="list-style-type: none"> • Automatic smoke detection and signalisation through smoke and heat detectors and manual alarming with the use of manual smoke extraction push buttons; • Smoke extraction from the staircase through the use of the mechanically forced air flow; • The possibility of using a smoke and heat vent and/or wall vent for smoke extraction from the staircase; • Manual activation/deactivation of the staircase ventilation - daily ventilation; • Communication with the FAS, BMS systems.
Additional information	<ul style="list-style-type: none"> • Low susceptibility to external factors (wind, temperature) affecting the smoke extraction effectiveness as compared to gravitational smoke extraction systems • The completeness of the set • Introduced to the market based on documents issued by CNBOP-PIB - National Technical Assessment, National Certificate of Constancy of Performance of the Product and the National Declaration of Performance issued by the producer; • Developed based on the experiences and results of physical tests conducted in the conditions of real fires - "Safe evacuation" project (www.bezpiecznaewakuacja.pl), • Adjusts the compensation air supply smoothly depending on the conditions in the building.

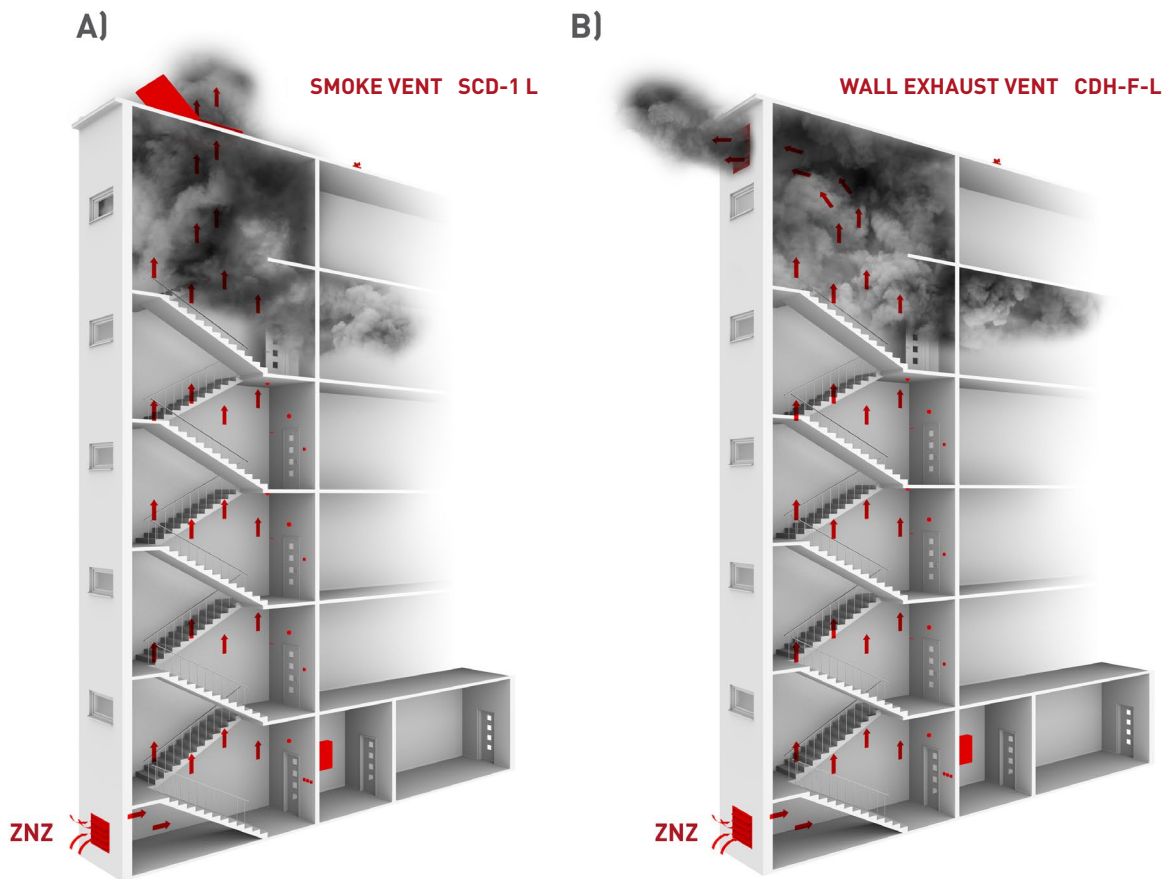



Figure 1. The ZODIC-M system with the mechanical compensation air-supply with the use of ZNZ set located in the ground floor of the building:
 A) With smoke release through the SCD-1-L smoke and heat vent,
 B) With smoke release through the CDH-F-L wall smoke vent.

ZODIC-M system components

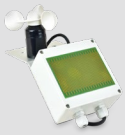

Table 2. The list of the ZODIC-M basic system components.

BASIC SYSTEM ELEMENTS		
SCD-1-L smoke and heat vent		It is intended for extracting smoke and hot and toxic gases which are emitted during the fire. It is equipped with measuring systems enabling the system operation with the variable compensation air-supply. There is an additional function of ventilation and an exit hatch. The declared aerodynamic free areas are presented in Table 4.
CDH-F-L wall smoke and heat vent with measuring system		The CDH-F-L wall smoke extraction device dedicated to smoke and hot and toxic gases extraction. It is equipped with the exhaust stream measuring system, enabling the adjustment of the compensation air-supply consumption. It is dedicated only to vertical installation. The aerodynamic free areas are presented in Table 5. NOTE: The CDH-F-L wall extraction vent is equipped with an actuator without a return spring which must be connected through the ASZ module.





BASIC SYSTEM ELEMENTS

ZNZ air supply unit		The ZNZ wall air supply unit consists of air-supply fans and an air intake opened with an actuator. It is used for the mechanical supply of compensation air to the staircase. It is mounted in the external wall of the staircase. The parameters of the ZNZ fans are included in Table 6.
AFC air-supply fans		The AFC axial duct fan is used for the mechanical supply of compensation air to the staircase by means of the ventilation ducts. The parameters of the AFC fans are included in Table 7. The fan accessories are presented in Table 8.
CDH-K compensation air intake		Used for taking compensation air. Equipped with an actuator opening the air intake during the activation of the system. CDH-K dimensions and effective areas are presented in Table 9. NOTE: The ZODIC-M system has the CDH-K air intake with an actuator with a return spring which does not require connecting through the ASZ module.
SRC damper		The SRC dampers are used to block the air supply from the staircase during the smoke extraction system stand-by in the installations equipped with air intakes with fixed vanes. Standard damper dimensions: width 300-1400mm, height 305-1405 mm. NOTE: The ZODIC-M systems uses the SRC damper with an actuator with a return spring which does not require connecting through the ASZ module.
MZS power supply-control module		The MZS module is dedicated to supply and control the ZODIC-M set components. It consists of two parts: <ul style="list-style-type: none"> • Power supply part - the power adapter of fire protection devices of the ZUP type ("ZUBR") - it satisfies the requirements of PN-EN 12101-10 and PN-EN 54-4 standard; • Control part - dedicated control unit of N-0200 fire protection devices - it holds the National Certificate of Constancy of Performance of the Product and the Approval Certificate. MZS is available in 7 main variants depending on the power of the fans being connected. Basic parameters are presented in Table 10. Each MZS may be extended with additional ZUP modules depending on individual needs.
WWZ fan switch		The WWZ fan switch is used for the emergency switching-off of the AFC air-supply fan or the ZNZ air supply unit by a person supervising a rescue and extinguishing action.
CDZ-2 smoke and heat detector		Smoke detectors are dedicated to smoke detection in a room (optionally smoke and heat). NOTE: It is not necessary to use the CDZ system smoke and heat detectors if a building is equipped with the FAS installation with smoke detectors in the staircase.
POZ smoke extraction manual push button		For the manual activation of the staircase smoke extraction set. Smoke extraction push buttons for ZODIC-M are available in 6 variants which differ in functionality and signalling diodes. Respective types are presented in Table 11. The POZ-2 switch is used in a standard version. NOTE: It is not necessary to use the POZ system smoke extraction push buttons if a building is equipped with the FAS system with push buttons in the staircase.

Table 3. The list of the ZODIC-M optional system components.

OPTIONAL SYSTEM ELEMENTS		
UPZ measuring system		The UPZ measuring system is used to adapt the existing smoke vent or a smoke ventilation window for operating in the ZODIC-M system with variable compensation air-supply.
CCZ pressure sensor		For the measurement of pressure difference in measuring systems and specifying a flow rate. Used for the adaptation of the existing smoke extraction elements together with the UPZ measuring system.
PPZ ventilation button		Used for the activation of staircase ventilation consisting in drawing the smoke vent aside (without opening the air compensation). The smoke vent is closed automatically after the expiration of the set time, manually after pressing the ventilation button or after receiving a signal from the weather station.
SPZ weather station		It detects rain and wind (only for the needs of ventilation). If the set frequency of rain and wind sensors is exceeded, the ventilation function is deactivated and the smoke vent is closed. SPZ also prevents the activation of the ventilation function during rain/too strong wind. The SPZ weather station is supplied with power from the building's 230V network in a standard version (and not from the MZS module).
SA acoustic signalling device		Used for the acoustic signalisation of fire inside buildings.

OPTIONAL SYSTEM ELEMENTS

SO optic signalling device		Used for the optic signalisation of fire inside buildings.
SAO acoustic-optic signalling device		Used for the acoustic and optic signalisation of fire inside buildings.
EZD door electric lock		Used for blocking the door in a closed position during the normal building operation. After the activation of the smoke extraction system, the lock is released, enabling door opening (manual or by means of an actuator). A standard type is opened after supplying voltage. A reverse type is opened after disconnecting voltage (locking maintenance requires voltage supply). NOTE: the standard electric lock must be connected through the AEZ module.
ETD electric door holder		Used for keeping the door in an opened position during the normal building operation. After the activation of the smoke extraction system, the electric holder is released, enabling door closing by means of the self-closer. This device is available in two versions: universal and with a rotating head (adjustable spacer pipe).
Adapter for ASZ rotary actuators		Intended for supplying with power and controlling the rotary actuators in which direction is not changed through polarisation change. In the ZODIC-M systems it is used together with the CDH-F-L wall vent (for actuators with the return spring).
Door electric lock adapter AEZ		For supplying with power and controlling the door actuators and for supplying with power and opening the standard electric locks. Used together with the END door actuators and with the standard EZD electric lock.

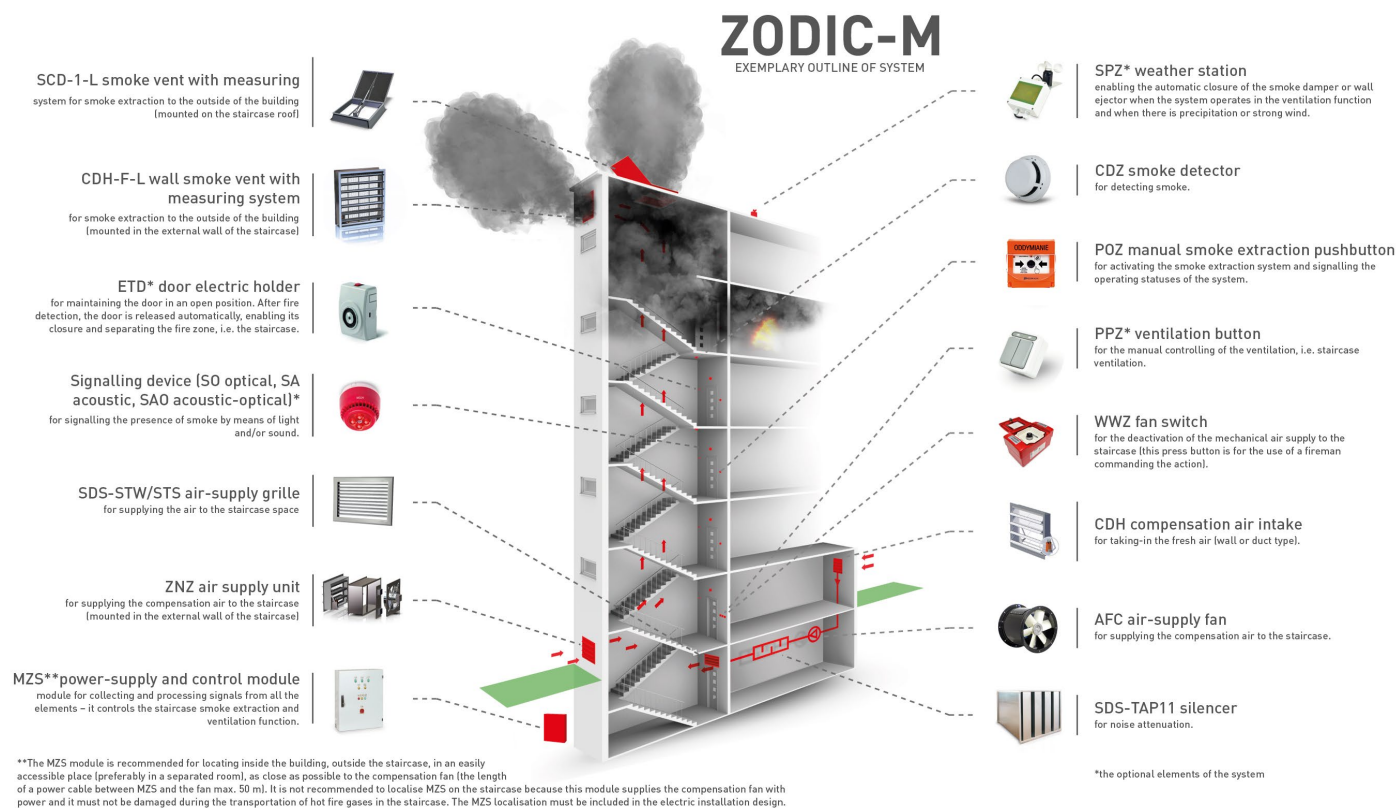

Figure 2. The exemplary outline of the ZODIC-M system.

Technical parameters

Table 4. The parameters of the SCD-1-L smoke and heat vents on a straight base, with two guide vanes, without an exit hatch function.

Nominal dimensions		Geometric area A_g [m ²]	Aerodynamic free area A_a [m ²]			Max. current consumption [A]
Width W [mm]	Length L [mm]		Base height H [mm]			SCD-1-P (without an exit hatch)
			350	500	700	
1000	1000	1,00	0,80	0,81	0,82	4
1000	1200	1,20	0,96	0,97	0,98	4
1000	1300	1,30	1,04	1,05	1,07	4
1000	1400	1,40	1,12	1,13	1,15	4
1000	1500	1,50	1,20	1,22	1,23	6
1000	1600	1,60	1,28	1,30	1,31	6
1000	1700	1,70	1,36	1,38	1,39	6
1000	1800	1,80	1,44	1,46	1,48	6
1000	1900	1,90	1,52	1,54	1,56	6
1000	2000	2,00	1,60	1,62	1,64	6
1000	2200	2,20	1,76	1,78	1,80	6
1000	2300	2,30	1,84	1,86	1,89	6
1000	2400	2,40	1,92	1,94	1,97	6
1000	2500	2,50	2,00	2,03	2,05	8
1100	1100	1,21	0,97	0,98	0,99	4
1100	2000	2,20	1,76	1,78	1,80	6
1150	1150	1,32	1,06	1,07	1,08	6
1150	2000	2,30	1,84	1,86	1,89	8
1200	1200	1,44	1,15	1,17	1,18	6
1200	1500	1,80	1,44	1,46	1,48	6
1200	1700	2,04	1,63	1,65	1,67	6
1200	1800	2,16	1,73	1,75	1,77	8
1200	2000	2,40	1,92	1,94	1,97	8
1250	1250	1,56	1,25	1,27	1,28	6
1300	1300	1,69	1,35	1,37	1,39	6
1300	1500	1,95	1,56	1,58	1,60	8
1300	1600	2,08	1,66	1,68	1,71	8
1300	1800	2,34	1,87	1,90	1,92	8
1300	1900	2,47	1,98	2,00	2,03	10
1300	2000	2,60	2,08	2,11	2,13	10
1300	2200	2,86	2,29	2,32	2,35	10
1300	2500	3,25	2,60	2,63	2,67	10
1400	1400	1,96	1,55	1,57	1,59	8
1400	1500	2,10	1,66	1,68	1,70	8
1400	1800	2,52	1,99	2,02	2,04	10
1400	2000	2,80	2,21	2,24	2,27	10
1400	2500	3,50	2,77	2,80	2,84	12
1450	1450	2,10	1,66	1,68	1,70	8
1500	1500	2,25	1,78	1,80	1,82	10
1500	1700	2,55	2,01	2,04	2,07	10
1500	1800	2,70	2,13	2,16	2,19	10
1500	2000	3,00	2,37	2,40	2,43	12
1500	2200	3,30	2,61	2,64	2,67	12
1500	2300	3,45	2,73	2,76	2,79	12
1600	1600	2,56	2,02	2,05	2,07	10
1600	1700	2,72	2,15	2,18	2,20	12
1600	1800	2,88	2,28	2,30	2,33	12
1600	2500	4,00	3,16	3,20	3,24	12
1700	1700	2,89	2,28	2,31	2,34	12
1700	1800	3,06	2,39	2,45	2,48	12

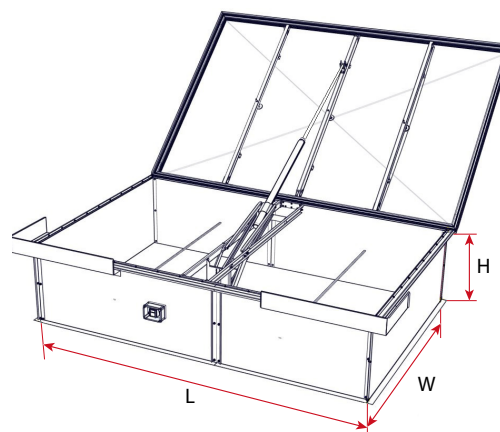

Figure 3. Single-wing smoke and heat vent on a straight base, with the SCD-1-L measuring system.

The ZODIC-M system handles smoke and heat vents with the maximum power consumption of 12A.



For the smoke and heat vents used in the ZODIC-M systems (with the measuring system), an exit hatch option is possible for the dampers with the length of $L \geq 1450$ mm

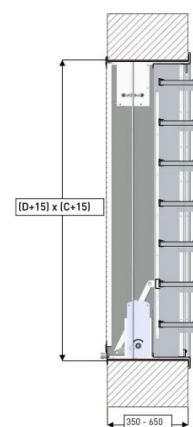

Figure 4. Wall smoke extraction vent with the measuring system CDH-F-L.



It is possible to adapt the existing exhaust devices (e.g. smoke vents, smoke ventilation windows) to the ZODIC-M set through equipping these devices with the UPZ measuring system.



smoke vents with deflectors

smoke vents without deflectors (the use of deflectors does not increase the aerodynamic free area)

Table 5. The aerodynamic free areas of the CDH-F-L wall vents.

Mounting Opening height D [mm]	Mounting opening width C [mm]							
	800	900	1000	1100	1200	1300	1400	1500
	Aerodynamic free area Aa [m²]							
940	0,40	0,45	0,51	0,56	0,62	0,68	0,74	0,79
1115	0,47	0,55	0,61	0,69	0,75	0,82	0,88	0,97
1290	0,56	0,64	0,72	0,80	0,83	0,91	1,00	1,07
1465	0,64	0,74	0,83	0,91	0,95	1,05	1,14	1,22
1640	0,72	0,83	0,93	1,04	1,09	1,18	1,30	1,40
1815	0,81	0,92	1,05	1,16	1,21	1,34	1,44	1,55
1990	0,89	1,01	1,15	1,27	1,35	1,47	1,59	1,73

Table 6. The parameters of the ZNZ air-supply unit.

Type	Electric power [kW]	Current [3x 400V] [A]	Sound pressure level (3 m.) L _{pa} [dB(A)]	Dimensions of mounting opening				Length outside the partition G [mm]	Weight m [kg]
				Horizontal version H		Vertical version V			
				Width C [mm]	Height D [mm]	Width C [mm]	Height D [mm]		
ZNZ-1	1,3	2,3	65	900	620	620	960	175	50
ZNZ-1J	1,1	2,4	65					260	62
ZNZ-1.5	1,5	3,1	69	1035	785	785	1135	175	70
ZNZ-1.5J	1,5	3,2	68					260	83
ZNZ-2.2	2,2	4,4	71	1135	960	960	1135	200	80
ZNZ-2.2J	2,2	4,4	68					290	109
ZNZ-3.0	3	7,4	82	1240	960	960	1310	330	110
ZNZ-3.0J	3	5,9	73					290	118
ZNZ-5.5	5,5	13,4	86	1355	1135	1135	1485	330	180
ZNZ-5.5J	5,5	10,5	79					290	167
ZNZ-2	2x 1,3	2x 2,3	68	1600	620	620	1660	175	82
ZNZ-2J	2x 1,1	2x 2,4	68					260	106

H – a horizontal version with an inspection panel on the side
V – a vertical version with an inspection panel on the bottom / top

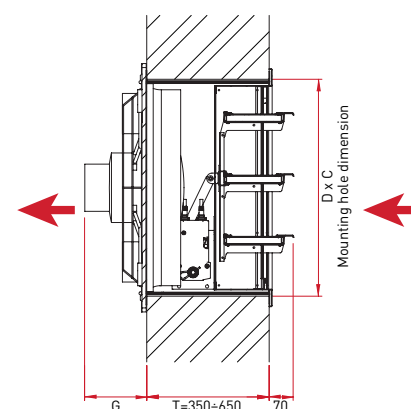

Figure 5. The ZNZ air-supply unit consisting of the fan and air intake with an actuator.

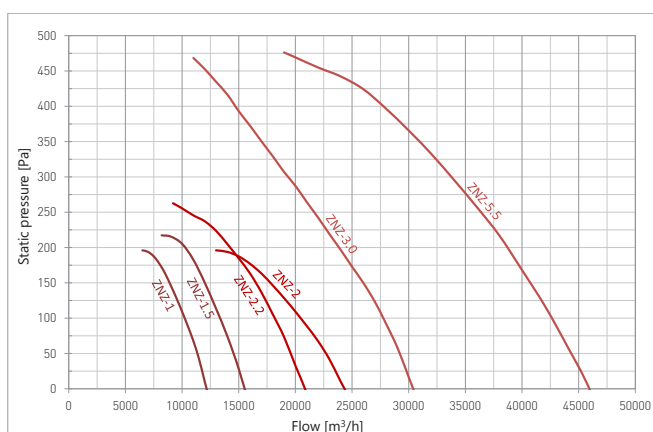

Chart 1. The ZNZ fan specifications.

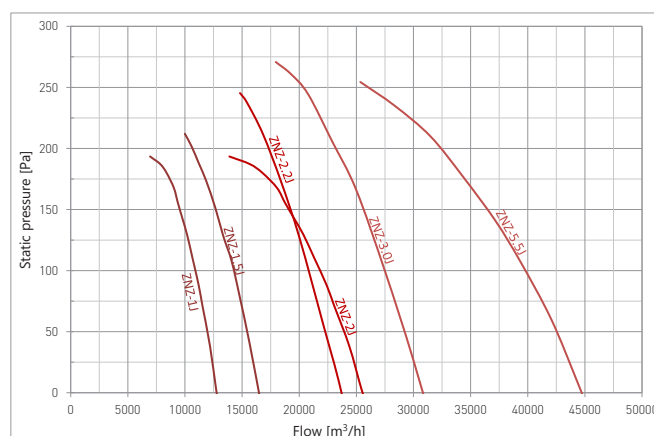

Chart 2. The ZNZ fan specifications.

Table 7. The parameters of the AFC air-supply fan.

Type	Motor power (3x 400V)	Current	Sound power level L _w [dB]								Sound power level L _{wa} [dB(A)]	Nominal diameter D [mm]	Collar diameter A [mm]	Length L [mm]	Weight M [kg]
	[kW]		[A]	63	125	250	500	1k	2k	4k					
AFC-1	2,2	4,7	89	96	95	94	92	89	88	84	97	560	660	450	51
AFC-2	4,0	7,4	92	91	91	91	92	90	91	87	98	560	660	450	62
AFC-3	1,1	2,5	80	77	75	76	75	75	76	70	82	630	736	500	53
AFC-4	1,5	3,7	82	79	77	77	76	75	76	73	83	630	736	500	63
AFC-5	2,2	4,8	83	80	78	80	80	79	79	72	86	630	736	500	78
AFC-6	4,0	8,7	87	84	82	81	82	80	79	76	87	630	736	500	92
AFC-7	2,2	5,1	87	86	85	85	85	84	84	79	91	800	900	620	99
AFC-8	4,0	8,7	90	91	91	92	91	88	88	84	96	800	900	620	105
AFC-9	5,5	11,1	92	90	92	90	89	88	88	84	95	800	900	620	114
AFC-10	7,5	14,7	93	90	92	90	89	89	88	84	96	800	900	620	135
AFC-11	7,5	14,6	91	90	90	90	90	89	91	88	97	1000	1100	730	230
AFC-12	11,0	21,2	94	94	92	93	92	92	92	89	99	1000	1100	730	245
AFC-13	15,0	28,3	97	94	92	90	89	88	86	80	95	1000	1100	730	239

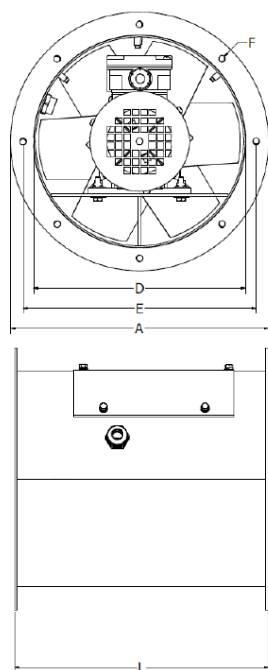

Figure 6. The AFC axial fan.

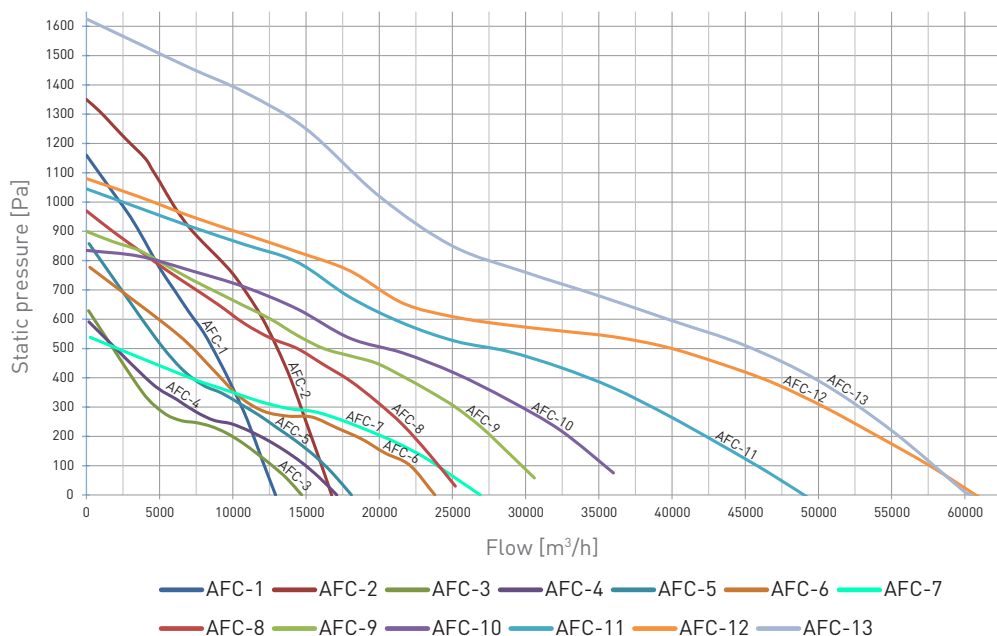

Chart 3. The AFC fan specifications.

Table 8. Accessories for the AFC fans.

Name of accessory for AFC	Flexible connector	Anti-collar	Horizontal mounting feet	Vertical mounting feet	Protective net	Rubber anti-vibration insulator	Rubber anti-vibration insulator
Abbreviation	KEK	PK	SM-H	SM-V	S0	AVM	DSD
Figure							

Technical tables

Table 9. The effective areas of the CDH-K wall air intake.

Number of blades [pcs.]	Mounting opening height	Mounting opening width C [mm]																	
		400	500	600	700	800	900	1000	1100	1200	1300	1400	1500	1600	1700	1800	1900	2000	2100
		Effective area A_{eff} [m ²]																	
3	590	0,16	0,20	0,24	0,28	0,32	0,37	0,41	0,45	0,49	0,53	0,57	0,62	0,66	0,70	0,74	0,78	0,83	0,87
4	765	0,21	0,27	0,32	0,38	0,44	0,49	0,55	0,61	0,66	0,72	0,78	0,83	0,89	0,95	1,00	1,06	1,12	1,17
5	940	0,27	0,34	0,41	0,48	0,55	0,62	0,70	0,77	0,84	0,91	0,98	1,05	1,12	1,20	1,27	1,34	1,41	1,48
6	1115	0,32	0,41	0,49	0,58	0,67	0,75	0,84	0,93	1,01	1,10	1,18	1,27	1,36	1,44	1,53	1,62	1,70	1,79
7	1290	0,38	0,48	0,58	0,68	0,78	0,88	0,98	1,08	1,19	1,29	1,39	1,49	1,59	1,69	1,79	1,89	1,99	2,09
8	1465	0,43	0,55	0,66	0,78	0,90	1,01	1,13	1,24	1,36	1,47	1,59	1,71	1,82	1,94	2,05	2,17	2,29	2,40
9	1640	0,49	0,62	0,75	0,88	1,01	1,14	1,27	1,40	1,53	1,66	1,79	1,92	2,05	2,19	2,32	2,45	2,58	2,71
10	1815	0,54	0,69	0,83	0,98	1,12	1,27	1,41	1,56	1,71	1,85	2,00	2,14	2,29	2,43	2,58	2,72	2,87	3,01
11	1990	0,60	0,76	0,92	1,08	1,24	1,40	1,56	1,72	1,88	2,04	2,20	2,36	2,52	2,68	2,84	3,00	3,16	3,32
12	2165	0,65	0,83	1,00	1,18	1,35	1,53	1,70	1,88	2,05	2,23	2,40	2,58	2,75	2,93	3,10	3,28	3,45	3,63
13	2340	0,71	0,90	1,09	1,28	1,47	1,66	1,85	2,04	2,23	2,42	2,61	2,80	2,99	3,17	3,36	3,55	3,74	3,93
14	2515	0,76	0,97	1,17	1,38	1,58	1,79	1,99	2,19	2,40	2,60	2,81	3,01	3,22	3,42	3,63	3,83	4,04	4,24
15	2690	0,82	1,04	1,26	1,48	1,70	1,91	2,13	2,35	2,57	2,79	3,01	3,23	3,45	3,67	3,89	4,11	4,33	4,55
16	2865	0,87	1,11	1,34	1,58	1,81	2,04	2,28	2,51	2,75	2,98	3,21	3,45	3,68	3,92	4,15	4,39	4,62	4,85
16	2900	0,87	1,11	1,34	1,58	1,81	2,04	2,28	2,51	2,75	2,98	3,21	3,45	3,68	3,92	4,15	4,39	4,62	4,85

Table 10. The series of types of standard MZS handling units.

	Max. power of the fed fan [kW] (3x 400V)	Min. current consumption from the network [A] (3x 400V)	Max. current consumption from the network [A] (3x 400V)	Min. dimensions		
				Width A [mm]	Height B [mm]	Depth G [mm]
MZS-1	1,5	0,18	Depending on the set configuration	700	800	250
MZS-2	2,2	0,2		750	800	250
MZS-3	4	0,23		750	800	250
MZS-4	5,5	0,28		750	850	250
MZS-5	7,5	0,32		750	850	250
MZS-6	11	0,4		750	900	280
MZS-7	15	0,49		750	900	280



The dimensions of the MZS handling units may be greater depending on additional functions. The standard MZS module does not supply the SPZ weather station with power and it is not equipped with the Reserve Self-Activation system.

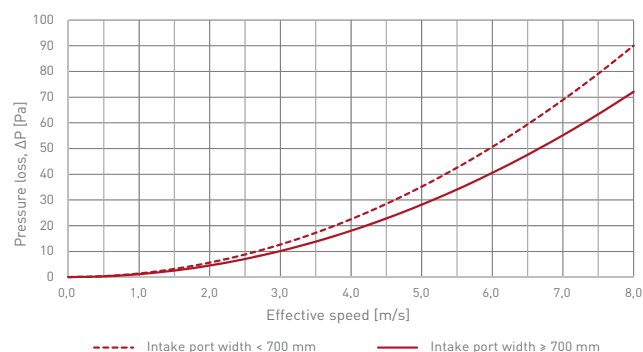

Chart 4. Pressure loss on the CDH-K air intake.

Table 11. The series of types of POZ smoke extraction push buttons.

	POZ-1	POZ-2	POZ-3	POZ-4	POZ-5	POZ-6
Push button for activating smoke extraction	+	+	+	+	+	+
Push button for cancelling smoke extraction	-	+	+	+	+	+
Ventilation ON/OFF button	-	-	-	-	+	-
Signalling diode	-	-	-	-	+	-
"Fire" Signalling diode	+	+	+	+	+	+
"Supervision" Signalling diode	-	-	+	+	+	+
"Damage" Signalling diode	-	-	+	+	+	+
Operation and failure acoustic signalling system	-	-	-	-	-	+



SMAY Company has created a selection software which enables the individual and independent selection of the complete ZODIC system in various configurations. The programme is available at:

<https://www.smay.pl/program-doboru-zodic/>